



Auto 8/10™

Platen Press

Equipment Manual

Auto 8/10TM

Platen Press



U.S. and other patents pending.

Manual applies to U.S. and International equipment.

MiTek Machinery Division
301 Fountain Lakes Industrial Drive
St. Charles, MO 63301
Phone: 800-523-3380
Fax: 636-328-9218
www.mii.com

Part Number	001102 Rev. C
Revision Date	12 April 2016
Revised By	R. Tucker
Approved By	M. Kanjee
Print Date	13 May 2016
Orig. Creation	unknown
Created By	Pacific Automation
Applicability	August 2014
Effectivity	30300-501-xxx 30500-501, 30520-501 30531-501 30296-501, 30293-501

Legal Notice

Patents

Made and sold under one or more of the following patents:

U.S. 4,986,052	U.S. 5,837,014	U.S. 6,219,975
U.S. 5,385,339	U.S. 5,854,747	U.S. 6,260,263
U.S. 5,493,834	U.S. 5,873,567	U.S. 6,317,980
U.S. 5,568,862,	U.S. 5,884,448	U.S. 6,389,762
U.S. 5,630,697	U.S. 5,885,731	U.S. 6,401,422
U.S. 5,636,494	U.S. 5,906,264	U.S. 6,412,246
U.S. 5,638,658	U.S. 5,934,866	U.S. 6,418,601
U.S. 5,640,832	U.S. 5,947,460	U.S. 6,539,615
U.S. 5,655,399	U.S. 5,987,828	U.S. 6,666,367
U.S. 5,678,395	U.S. 5,996,303	U.S. 6,702,269
U.S. 5,702,095	U.S. 6,048,165	U.S. 6,758,022
U.S. 5,707,204	U.S. 6,112,968	U.S. 6,817,392
U.S. 5,735,087	U.S. 6,134,775	U.S. 6,834,470
U.S. 5,810,341	U.S. 6,170,688	U.S. 6,907,820
U.S. 5,819,412	U.S. 6,205,637	Other patents may apply
U.S. 5,833,222	U.S. 6,212,849	

Return Goods Policy

Return goods cannot be accepted without prior authorization and are subject to a restocking charge. The Seller certifies the articles specified herein were produced in compliance with all provisions of the Fair Labor Standards Act of 1938, as amended, including Section 12.—Rev. 6/98

Reporting Errors and Recommending Improvements

To report errors or recommend improvements to this manual, please complete the Document Evaluation Form in the appendices. Mail or fax the form to:

MiTek Machinery Division
301 Fountain Lakes Industrial Drive
St. Charles, MO 63301
Attn: Engineering Manager, Fax: 636-328-9218

Contents

Preliminary Pages

Legal Notice	iii
Contents	iv
Notice of Change	ix

Safety (English)

Safety Indicators: Signal Words	x
General Equipment Safety Rules	xi
Lockout/Tagout	xiv
Lockout/Tagout Guidelines	xiv
Electrical Lockout/Tagout Procedures	xv
Hydraulic System Lockout/Tagout Procedure	xviii
Pneumatic System Lockout/Tagout Procedure	xviii
Troubleshooting With an Energized Machine	xviii
Restricted Zone	xix
Know the Restricted Zone	xix
Marking the Restricted Zone	xx
Safety Tests	xxi
Testing/Adjusting the Scanner	xxi
Testing the Dashboard E-Stop Button	xxii
Testing the Head E-Stop Button	xxiii
Testing the Control Power Key Switch	xxiv
Inspection	xxiv
Testing the Stopping Distance	xxv
Safety Symbol Definitions	xxvi
Declaration of Safety Conformity	xxxiv

Introduction

Chapter 1

Introduction to the Manual	1
Purpose and Scope of This Equipment Manual	1
The Drawing Set	2
Navigation	2
Additional Resources	3
Supplemental Documentation	3
Web Site	3
Contacting Us	3

General Information

Chapter 2

Introduction to the Equipment	4
Purpose of the Equipment	4
Description of the Equipment	4
Operating and Safety Note Highlights	4
Getting the Most From Your Machine	5
Main Components and Optional Equipment	6
Component Overview	6
J-Slot vs. T-Slot	6
Technical Specifications	7
General Specifications	7
Environmental, Transportation, and Handling Specs	8
Truss Terminology	9

Contents

Prior to Installation	Chapter 3
MiTek Responsibilities	11
Prior to Installation	11
During Installation	11
Customer Responsibilities	12
Space Requirements	13
Location Requirements	15
Electrical Requirements	16
Hydraulic System Requirements	17
Pneumatic System Requirements (For Optional Floor Jigging) . . .	18
Shipping Information	18
Customer-Supplied Parts	19
Local Codes and Regulations	20
Training Provided	20
Delivery	20
Checking for Damage	20
Unloading	21
Installation	Chapter 4
Responsibilities During Installation	24
General Installation Requirements	25
Installation Procedure	26
Installing the Table and Preparing for the Head	26
Installing the Gantry Head	28
Pneumatic System	31
Anchoring to the Floor	31
Marking Restricted Zone	32
Marking Area On Your Own	32
Installing Tape Purchased From MiTek	32
Startup	Chapter 5
Preparing for Startup	34
Preparing the Hydraulic System	35
Filling the Reservoir With Hydraulic Fluid	35
Priming the Pump	35
Checking Motor Rotation	36
Safety Tests	36
Operation	Chapter 6
Before You Begin	37
Safety Operating Notes	37
Stopping and Moving the Machine in an Emergency	39
Manually Moving the Press Head or Platen	41
Controlled Stop Procedure	43
How Stopping Works	43
Starting the Machine	43
Operator Control Interface and Dashboard	44
Building a Roof Truss	47
Setting Up a Roof Truss on a T-Slot Table Top	47

Contents

Setting Up a Roof Truss on a J-Slot Table Top	48
Pressing a Roof Truss	49
Building Floor Trusses	52
Recommended Method of Building a Floor Truss	52
Setting Up a Typical Floor Truss	53
Pressing a Floor Truss	57
Inspecting the Finished Trusses	60
Restart Procedure	61
Maintenance	Chapter 7
Introduction to Maintaining Your Equipment	62
Performing Maintenance Safely	63
Before Operating This Equipment	63
Lockout/Tagout	64
Important Safety Information	64
Making Adjustments and Replacing Parts	66
Wearing Personal Protective Equipment	67
Conducting Safety Tests	67
Overview Graphics	68
Hydraulic Fluid Maintenance	69
Hydraulic Fluid Specifications and Information	69
Hydraulic Fluid Inspection	70
Filling the Hydraulic Fluid Level	71
Reading the Oil Filter Bypass Gauge	73
Replacing the Hydraulic Fluid Filter Element	74
Replacing the Hydraulic Fluid	75
Hydraulic System Maintenance & Repair	78
Overview of Hydraulic Manifold and Valves	78
Understanding the Table Valves	80
Adjusting the Pressure Setting	81
Replacing a Hydraulic Valve	83
Replacing Hydraulic Hoses	85
Priming the Pump	88
Hydraulic Cylinder Replacement & Repair	89
Removing the Hydraulic Pressing Cylinder and Rod Eye	89
Removing the Cylinder Rod Eye from the Cylinder	92
Disassembling the Pressing Linkage	93
Mechanical Inspection	97
Adjusting the Platen Height (Up Limit Switch)	98
Track and Wipers	100
Wheels & Rollers	101
Inspecting Drive and Idle Wheels	101
Replacing a Drive or Idle Wheel	103
Leveling the Drive and Idle Wheels	107
Adjusting Guide Wheels for Gantry Head Tracking	110
Jigging	112
Cleaning	112
Daily Cleaning Procedure	112

Periodic Cleaning Procedure	113
Lubrication	114
Lubricate Daily	117
Lubricate Weekly	120
Lubricating Drive and Idle Wheel Bearings	121
Lubricating Table Guide Roller Bearings	123
Solutions for Inadequate Stopping Distance	125
Replacing a Drive Motor	126
Maintaining Electrical & Safety Assemblies	128
Maintaining the Scanner	128
Replacing Horn and Beacon	129
Maintaining Electrical Track Components	131
Electrical System Components	134
Electrical Inspection	134
Motor Overload Settings	135
Replacing the Control Power On Light	136
Pneumatic System	137
Overview	137
Regulator	138
Troubleshooting Unusual Noises	140
Troubleshooting	
Appendix A	141
Safety Notes for Troubleshooting	141
General Troubleshooting Safety Tips	141
Electrical Troubleshooting Safety Tips	141
Getting Started With Troubleshooting	143
Tools Needed	143
The First Steps	143
Symptoms and Solutions	145
For Machines Manufactured Prior to 2012	151
General Description of ESM Safety Circuit	151
Description of the 4 Lights (LED's) on the ESM	151
LED Light Status	152
ESM Troubleshooting Procedure	153
Navigating the Parts List Appendix	155
Finding the Part Number	155
Ordering the Parts With Your Part Number	155
Parts List	
Appendix B	155
Safety Notes for Replacing Parts	156
Part Numbers	157
Mechanical, Hydraulic, and Pneumatic Parts	157
Electrical Parts	157
Documentation, Operation, and Safety Parts	157
Maintenance Checklists	
Appendix C	158

Navigating the Maintenance Checklists	158
Safety Notes For Maintenance Checklists	159
Daily Checklist	160
Weekly Checklist	161
Monthly Checklist	162
Annual Checklist	163
Drawing Set	
Appendix D	164
Document Evaluation	
Appendix E	165
Glossary	168

Notice of Change

Use this page to record Service Bulletins and Notices that you receive to keep your manual updated.

Auto 8/10™
Platen Press

Service Bulletin or Notice #	Dated	Title

Safety (English)



Refiérase a la página viii para español.

For safety information in Spanish, refer to page viii.

Safety Indicators: Signal Words

The following signal words and colors are used throughout this document to indicate safety hazards. Pay careful attention when you see them. The level of severity differs for each signal word and color.

Signal words are accompanied by graphics showing what personnel should or should not do. The graphics are called safety symbols and are defined on page xxvi, but more specific text is provided every time a graphic is used throughout the manual. Everyone near the machine must be trained on how to read these safety indicators.

Failure to comply with the instructions accompanying each signal word may result in property damage, personal injury, or even death. Personnel must follow all safety procedures and practices to ensure the safest possible operation of this equipment. However, at no time is this document a substitute for common sense. Personnel must ensure that the work environment is safe and free of distractions.

DANGER

Indicates an imminently hazardous situation which, if not avoided, is likely to result in death or serious injury.

WARNING

Indicates a potentially hazardous situation which, if not avoided, may result in death or serious injury.

CAUTION

When CAUTION is used **with** the safety alert symbol (yellow triangle), it indicates a potentially hazardous situation which, if not avoided, may result in minor or moderate injury.

When CAUTION is used **without** the safety alert symbol, it indicates a potentially hazardous situation which may result in equipment damage.

NOTICE

Calls attention to information that is significant to understanding the operation at hand.

ENVIRONMENTAL

Applies to conditions that may affect the environment but do not have an immediate, direct effect on personnel or equipment.

General Equipment Safety Rules



Because it is impossible to anticipate every circumstance that might involve a hazard, the safety information provided in this equipment manual and on the machine is not all-inclusive. If this machine is operated or serviced using a procedure not specifically recommended by the manufacturer, the procedure shall be approved by a professional engineer to ensure it will not render the equipment unsafe. Use extreme caution and common sense at all times!



Safety tests are on page xxi.

Know Your Equipment

- Read this manual completely before using or maintaining the equipment. Do not operate this machine unless you have a thorough knowledge of the controls, safety devices, emergency stops, and operating procedures outlined in this manual.
- Read and follow all safety notes. Failure to comply with these instructions may result in economic loss, property damage, and/or personal injury including death.
- Refer to the lockout/tagout guidelines on the following pages to safely perform maintenance and troubleshooting of this equipment.
- Observe and obey all safety labels. Replace worn labels immediately.
- Use this equipment solely for the purpose described in this manual.
- Only qualified personnel should attempt to operate or perform maintenance on this equipment. “Qualified personnel” is defined as:

...a person or persons who, by possession of a recognized degree or certificate of professional training, or who, by extensive knowledge, training, or experience, has successfully demonstrated the ability to solve problems relating to the subject matter and work—ANSI B30.2-1983

...one who has skills and knowledge related to the construction and operation of the electrical equipment and installations and has received safety training on the hazards involved—NEC 2002 Handbook

Personal Safety

- Always wear safety glasses and hearing protection in an industrial environment.
- Utilize a filtering face piece (dust mask) when working near sawdust.
- Wear proper clothing and appropriate personal protective equipment (e.g., safety glasses and hearing protection.) Do not wear loose clothing or jewelry. Confine long hair by tying it back.
- Use caution when lifting heavy parts or material.

Installing the Equipment

- Follow installation instructions completely.
- This equipment is not for use in a residential area.



Lockout/Tagout

- Before performing maintenance on the pneumatic or hydraulic systems, bleed the lines to eliminate pressure.
- Lockout/tagout all energized systems before performing maintenance on them. Refer to the *Lockout/Tagout Guidelines* section on page xiv.

Keeping a Safe Environment

- Keep children away. All visitors should be kept a safe distance from the work area. Hazards may not be apparent to individuals unfamiliar with the machine.
- Keep work areas well lit.
- Keep the work area clean and free of any trip or slip hazards.
- Do not use the equipment in damp or wet locations, or expose it to rain or snow.
- Minimize dust clouds and protect your equipment by cleaning dust in this manner:
 - Vacuum dust prior to blowing with air
 - Shut down electrical power and sources of ignition
 - If using compressed air, it should be a low compression (no more than 15 psi)
 - Powered cleaning equipment such as vacuums must be consistent with local governmental codes for use in dusty conditions.

Operating and Maintaining the Equipment

- Ensure that all people, tools, and foreign objects are clear of the restricted zones before operating this equipment. The restricted zones are shown on page xix.
- Perform safety tests to ensure all E-stops are working properly before operating the equipment at the initial startup, after performing any maintenance, and in accordance with the maintenance schedule.
- In case of machine malfunction, stop the machine immediately using an E-stop and report the malfunction to a supervisor.
- Never leave the machine running unattended. Turn the power off! Do not leave the machine until all parts have come to a complete stop and all electrical power has been shut off.
- Check for worn or damaged parts regularly. Repair or replace them immediately.
- Keep the hydraulic, pneumatic, and electrical systems in good working order at all times. Repair leaks and loose connections immediately. Never exceed the recommended pressure or electrical power.

- Check that all safety devices are in working order before each shift starts. All protective guards and safety devices must be in place before and during use of the machine. Never disconnect or bypass any safety device or electrical interlock.
- Only qualified maintenance personnel shall remove or install safety devices.
- Periodically inspect the quality of the finished product.

Electrical Safety

- Do not use any liquids in the interior of electrical cabinets.
- When using solvents on and around the machine, remove power to the machine to eliminate the chance of sparking, resulting in explosion or fire. Wear a respirator approved for use with solvents. Wear protective clothing, gloves, and safety glasses.

Lockout/Tagout

Lockout/Tagout Guidelines

All lockout/tagout guidelines must be met according to OSHA 29 CFR 1910.147. A specific procedure should be included in your company's energy control program. This manual is not intended to replace your company's de-energizing or lockout/tagout procedure required by OSHA, but merely to provide general guidance.

The term "lockout," as used in this manual, means placing a lockout device on any and all energy sources to ensure that the energy isolating device and the equipment being controlled cannot be re-energized or operated until the lockout device is removed. The photos on the next page show where the electrical disconnects are located for this machine.



- Energy sources include electrical, mechanical, hydraulic, pneumatic, chemical, thermal, or other energy.
- In the case of electrical energy sources, the main power and control power to the machinery must be turned off and physically locked in the "off" position.
- A lockout device is usually a keyed padlock.
- If more than one person is working in a restricted zone, use a group lockout device that will allow each person to use a lock that can be removed only by the person performing the maintenance.

"Tagout" means that a prominent warning is securely fastened to an energy-isolating device to indicate that the equipment shall not be operated.

Whenever you see this symbol, lockout/tagout!



Electrical Lockout/Tagout Procedures





When Working on a Machine Outside the Machine's Main Electrical Enclosure



If working on the electrical transmission line to the machine, follow the procedure on page xvii.

Before performing maintenance on any machine with electrical power, lockout/tagout the machine properly. When working on a machine outside of the machine's main electrical enclosure, not including work on the electrical transmission line to the machine, follow your company's approved lockout/tagout procedures which should include but are not limited to the steps here.

1. Engage an E-stop on the machine.
2. Turn the disconnect switch handle to the "off" position. See page xvi.

	 WARNING
	<p>ELECTROCUTION HAZARD.</p> <p>When the disconnect switch is off, there is still live power within the disconnect switch's enclosure. Always turn off power at the building's power source to the equipment before opening this electrical enclosure!</p>

3. Attach a lock and tag that meet OSHA requirements for lockout/tagout.
4. Restrain or de-energize all pneumatic components, hydraulic components, and other parts that could have live or stored power.

Figure 2-1: Sample of a Lockout/Tagout Mechanism



Figure 2-2: Auto 8/10 System Lockout, Located on End of Table

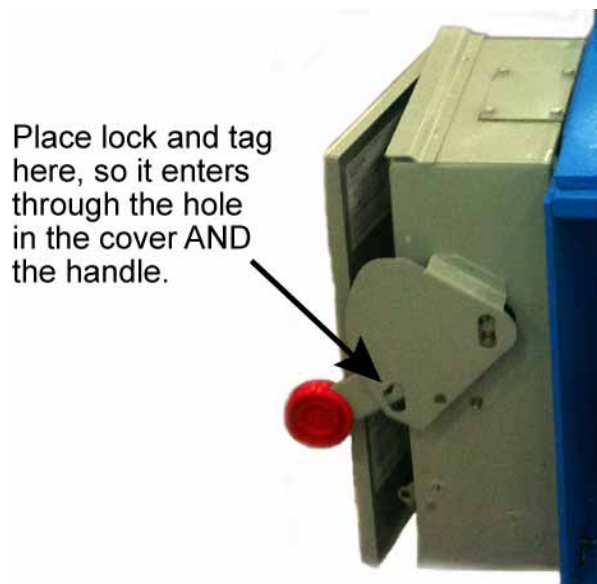



When Working on a Machine Inside the Machine's Main Electrical Enclosure or in the Electrical Transmission Line to the Machine

Before opening the main electrical enclosure or attempting to repair or replace an electrical transmission line to the machine, lockout/tagout the machine properly. Follow your company's approved lockout/tagout procedures which should include, but are not limited to the steps here.

1. Engage an E-stop on the machine.
2. Shut the power to the machine off at the machine's power source which is usually an electrical service entry panel on the facility wall. One example of a locked-out power source panel is shown in Figure 2-3.
3. Attach a lock and tag that meets OSHA requirements for lockout/tagout.
4. Open the door to the enclosure in which you need access and using a multimeter, verify that the power is off.

Figure 2-3: Sample of a Lockout/Tagout Mechanism on a Power Source Panel



Hydraulic System Lockout/Tagout Procedure

When Lockout/Tagout is Not Required

If working on components other than the hydraulic system that requires you to be near the vicinity of movable hydraulic components, you must, at a minimum, physically restrain the hydraulic components from moving. If this is not possible, lockout/tagout the entire hydraulic system. This is accomplished by placing a 4x4 or larger block under both ends of the platen, then bleeding hydraulic fluid from the two hoses at the hydraulic return line filter to release pressure.



When Lockout/Tagout is Required

Before attempting repair or performing maintenance on a hydraulic line or component, lockout/tagout the machine properly. Follow your company's approved lockout/tagout procedures and the guidelines in this section.

Pneumatic System Lockout/Tagout Procedure

When Lockout/Tagout is Not Required

If working on components other than the pneumatic system that requires you to be near the vicinity of movable pneumatic components, you must, at a minimum, physically restrain the pneumatic components from moving. If this is not possible, lockout/tagout the entire pneumatic system.



When Lockout/Tagout is Required



Before attempting repair or maintenance on a pneumatic line or component, lockout/tagout the machine properly. Follow your company's approved lockout/tagout procedures and the guidelines in this section.

Troubleshooting With an Energized Machine

Only a qualified electrician, using the personal protective equipment and following the procedures recommended in NFPA 70E should ever attempt service or repair of or near an energized area or component of the machine.

Whenever maintenance is performed while the equipment is electrically energized, there is a potential electric arc flash hazard. Refer to NFPA 70E for the personal protective equipment required when working with electrically energized components. Pneumatic and hydraulic components may move unexpectedly if not de-energized. Physically restrain any components capable of movement when working on or near those components.

Restricted Zone

	 DANGER
	<p>Stay out of the restricted zone when equipment is in use. Serious injury or death may result if personnel are in the restricted zone.</p> <p>Always look for personnel in the restricted zone before operating equipment.</p>



Safety tests are on page xxi.

Know the Restricted Zone

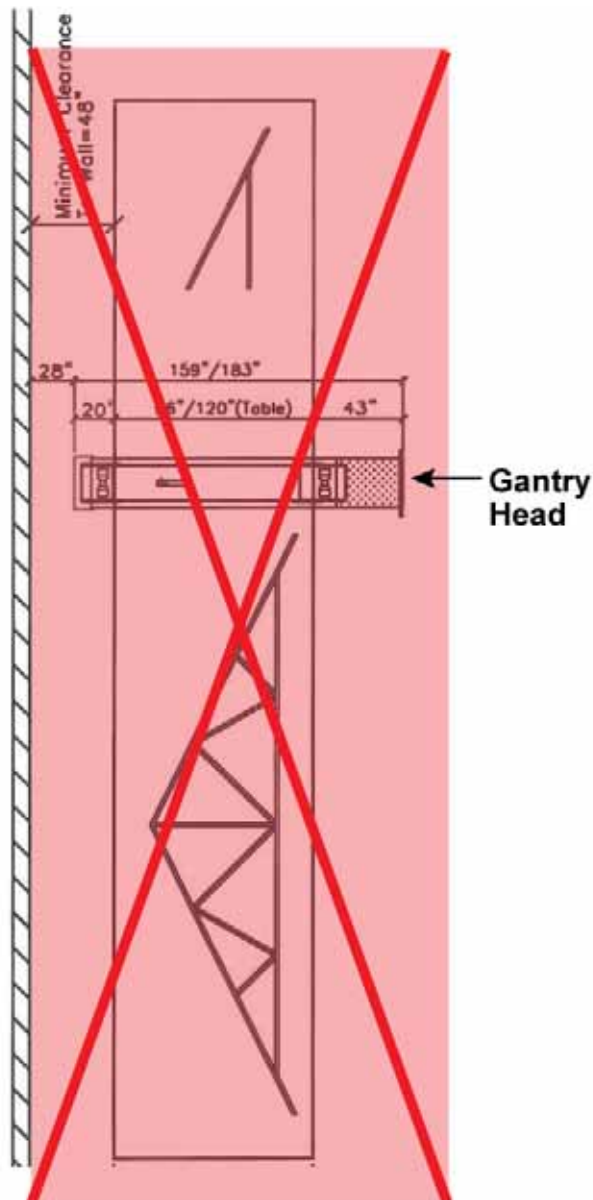

Marking the Restricted Zone

The restricted zone must be marked so everyone near the equipment can clearly see the area where danger may exist.

- PN** MiTek offers Restricted Zone Tape that is easy to apply and has text in English and Spanish. Some equipment comes with restricted zone tape. If your machine did not come with restricted zone tape, you may order it from MiTek Machinery Division Customer Service.

Instructions for where and how to apply restricted zone tape can be found in the gantry manual that came with your system (see page 32) or by obtaining Service Bulletin 181 from the MiTek Machinery Web site.



Safety Tests

This test procedure **MUST** be performed by qualified personnel at startup and after ANY maintenance, adjustment, or modification. Testing ensures that the safety system and machine control system work together to properly stop the machine.



Tape measure

Testing/Adjusting the Scanner



	 WARNING
	<p>Never insert hands, arms, or any foreign object into the restricted areas for any reason at any time.</p> <p>Never operate the machine if a scanner, warning beacon, or horn is not functioning correctly.</p> <p>Do not defeat any safety feature.</p>

Test the scanner daily to ensure that it shuts off the press if it senses an obstruction.

1. With the gantry head sitting at one end of the table, place an object higher than 3 in. tall on the table, at least 4 ft away from the scanner.
2. Start the electric motor and begin traveling the gantry head toward the obstruction.
3. The scanner should sense the obstruction when it gets within 32 in. of the scanner, which will cause the gantry head to stop its horizontal travel.
4. There is no way to adjust the scan area. If the scanner is not operating as expected, it is either a damaged scanner or an electrical problem. Have a qualified electrician troubleshoot and repair the problem.

Figure 2-4: Scanner



	 WARNING
	<p>Do not operate the equipment if the scanner is not functioning correctly.</p>



Testing the Dashboard E-Stop Button

Test the dashboard E-stop button daily to ensure that it shuts off the press.

Figure 2-5: Dashboard



1. Press the START button to turn on the control power. The green CONTROL POWER ON light and electric motor will start, indicating that the machine is ready to be operated.
2. Press the E-stop button to shut off the machine. The green CONTROL POWER ON light should go off and the electric motor should stop.
3. Check to ensure the button presses properly and the button head (which reads E-STOP) is not missing or broken.
4. The yellow decal reading E-STOP must also be in place.
5. Repair /replace a defective button head or decal as required.
6. If the E-stop button isn't functioning properly, have a qualified electrician troubleshoot and repair the problem.

	 WARNING
	Do not operate the equipment if an E-stop button is not functioning correctly.

Testing the Head E-Stop Button

Test the head E-stop button (on the cylinder end, opposite the operator end) daily to ensure that it turns off the press. The location is shown on Figure 2-6.





Refer to Figure 2-5 for location of control mechanisms.

1. Press the START button to turn on the control power. The green CONTROL POWER ON light and electric motor will start, indicating that the machine is ready to be operated.
2. Press the head E-stop button to shut off the machine. The green CONTROL POWER ON light should go off.
3. Check to ensure the button presses properly and the button head is not missing or broken.
4. The yellow decal reading *Emergency Stop* must also be in place.
5. Repair or replace a defective button head or decal as required.
6. If the E-stop button isn't functioning properly, have a qualified electrician troubleshoot and repair the problem.

Figure 2-6: Head E-Stop



	 WARNING
	<p>Do not operate the equipment if an E-stop button is not functioning correctly.</p>





Refer to Figure 2-5 for location of control mechanisms and indicators.

Testing the Control Power Key Switch

1. Turn the Control Power Key switch to the Off position and perform this test:
 - a) Ensure that both E-stop pushbuttons are in their extended (working) positions and the both scanner lights on the dashboard are green.
 - b) Press the joystick to the left and the right.
No movement should occur. If it does, test the electrical system.
 - c) Press the joystick down.
No movement should occur. If it does, test the electrical system.

2. Turn the disconnect switch on the machine's main electrical enclosure to the OFF position to test that it prevents power from reaching the dashboard:
 - a) Ensure that both E-stop pushbuttons and both pushbars are in their extended (working) positions.
 - b) Press the joystick to the left and the right.
No movement should occur. If it does, test the electrical system.
 - c) Press the joystick down.
No movement should occur. If it does, test the electrical system.

	 WARNING
	Do not operate the equipment if the Control Power Key Switch is not functioning correctly.

Inspection

A green CONTROL POWER ON light on the dashboard is energized when the START button is pressed and the safety circuits are functioning properly. This provides a visual indication that the machine will operate if the controls are activated. Inspect this light daily to ensure it illuminates when power reaches the dashboard.



The warning horn and beacon should be energized when the machine is traveling. If the beacon doesn't work, the bulb will require replacing. Check daily to ensure the horn and beacon are working.

Testing the Stopping Distance

After all E-stops and indicators have successfully passed their test, perform this test to ensure the gantry head stops horizontal travel as expected.

1. Press the START button to turn on the control power. The green CONTROL POWER ON light and electric motor will start, indicating that the machine is ready to be operated.
2. Press the joystick to the right or left to begin horizontal travel.
3. Activate any E-stop pushbutton to shut off the machine. The following should happen:
 - The green CONTROL POWER ON light should turn off.
 - The gantry head should come to a quick but smooth stop.
 - The platen should cease movement.
4. Ensure the scanner stops as directed on page xxi.
5. Press the joystick to the right or left to begin horizontal travel. When the scanner senses the obstacle, the following should happen:
 - The green CONTROL POWER ON light should turn off.
 - The gantry head should come to a quick but smooth stop.
 - The platen should cease movement.

If the press behaves as outlined in this procedure, it is ready to safely use. If any behavior conflicts with the expectations set in this procedure, have a qualified electrician troubleshoot and repair the failure.

	 WARNING
	<p>Do not operate the equipment if any safety device is not functioning correctly.</p>

Safety Symbol Definitions

The safety symbols shown in this section can be found throughout the manual to indicate hazards that are related to this equipment. All personnel expected to operate or maintain this equipment should become familiar with these safety symbols and what they mean.



This is the Electrical Hazard Symbol. It indicates that there are dangerous high voltages present inside the enclosure of this product and/or that a power source is present. To reduce the risk of fire or electric shock, do not attempt to open the enclosure or gain access to areas where you are not instructed to do so. Refer servicing to qualified service personnel only.

This product should be operated only from the type of source indicated on the manufacturer's identification label. Installation should be in compliance with applicable sections of the national electric code. Consult your local building code before installing.



This is the user caution symbol. It indicates a condition where damage to the equipment resulting in injury to the operator could occur if operational procedures are not followed. To reduce the risk of damage or injury, refer to accompanying documents, follow all steps or procedures as instructed.



Hot surface! Surface temperature can exceed greater than 70°C during normal operation. Do not touch.



Operation of this equipment may result in flying debris and excessive noise. To reduce the risk of injury, wear only approved PPE.



Crush hazard! Keep hands clear.





(1) Risk of fire
(2) Ignition sources present.



Keep feet away from moving parts.



Keep hands away from moving parts.



High pressure hose. Use appropriate PPE when working on equipment. Maintain safe pressure levels at all times.



Hydraulic hose is under great pressure. Use safe operating procedures at all times.



Do not use sling equipment rated for less than ____ lbs/ ____ kgs when lifting this equipment.



Slip hazard! Use of approved footwear is required.



Trip hazard! Pay attention when walking in this area.



Keep hands and body clear.





Warning! 3-man lift is required to safely move this equipment.





The operation of this equipment requires the use of PPE.
Do not operate without wearing required protective clothing.





Refer to manual- After installation, read the user's guide carefully before operating. Follow all operating and other instructions carefully.



Circuits are live -lockout/tagout the upstream disconnecting means prior to opening for service.



Lockout in a de-energized state



Lift Point - In order to reduce the likelihood of damage to the equipment, use only the lift points indicated in the manual.



To reduce the risk of personnel or equipment damage, maintain pressure at safe levels.



Use of lift equipment is mandatory.



Consult material safety data sheet.



Read all safety warnings and instructions before proceeding.



Hazardous moving parts are located behind this access panel. Do not operate this equipment without all guards and covers in place.



No lift point. Do not lift this device with a hook/crane assembly. Damage to the equipment will be incurred. Refer to the installation instructions.



Do not use non-approved lubricants in this machine.



Unauthorized persons are not allowed beyond this point.



Do not operate without guards and covers in place



Do not discard into municipal waste stream



oil drop

Declaration of Safety Conformity



All safety devices on this equipment are compliant with United States safety regulations and conform to current NEC, NFPA79, OSHA 21 CFR 1910, and UL regulations.

Electrical components also adhere to international safety codes including, but not limited to, IEC 6149, EN 954 and/or ISO 13849.

Purpose of Chapter

This chapter explains how to navigate through the equipment manual and how to contact MiTek.

Introduction to the Manual

 WARNING	
	<p>Read this manual completely before using this equipment!</p> <p>Do not operate this machine until you have a thorough understanding of all controls, safety devices, emergency stops, and operating procedures outlined in this manual.</p> <p>All hazard instructions must be read and observed. Failure to do so may result in economic loss, property damage, and/or personal injury.</p> <p>This manual must always be available to personnel operating and maintaining this equipment.</p>

Purpose and Scope of This Equipment Manual

In order for this equipment manual to be useful, the manual must be kept in a location where operators and maintenance personnel have easy access to it.

This manual addresses the most recent versions of the equipment as of the creation or revision date on the title page. For earlier revisions, contact MiTek Machinery Division Customer Service. The part number is listed on the title page, but the revision you require depends on the date your equipment was manufactured. This manual can be a valuable tool for training.

- The *Introduction* and *General Information* chapter contains information on truss terminology and provides basic information about the equipment.
- The *Operation* chapter teaches operators how to efficiently operate the machine.
- The *Maintenance* chapter is written specifically for maintenance personnel.
- The appendices provide valuable training materials and technical information to keep your equipment running.







The Drawing Set

A list of drawings can be found in the *Drawing Set* appendix. The actual drawings are either in a separate 11x17 binder or in the back of this Equipment Manual.

Navigation

The graphics in Table 1-1 are used throughout the manual to quickly communicate a specific type of information.

Table 1-1: Navigational Tools Used Throughout the Manual

Graphic	Explanation
	<p>Important safety note!</p> <p>Indicates that you must lockout/tagout at the disconnect switch located on the equipment using approved methods described in OSHA 29 CFR 1910.147 before continuing with the procedure.</p>
	<p>Indicates tools required before beginning a procedure.</p>
	<p>Gives additional information to the steps or text.</p>
	<p>Indicates how to get to or from the item discussed.</p>
	<p>Refers reader to another section, table, graphic, or drawing for further explanation.</p>
	<p>Indicates that the part number is listed in the <i>Parts List</i> appendix. If viewing the manual electronically, click the icon to go to the <i>Parts List</i> appendix.</p>

Additional Resources

Supplemental Documentation

In addition to the equipment manual, refer to the documentation provided by the original manufacturer. The supplemental documentation is provided at the time of installation or may be found inside an electrical enclosure. Refer to these documents when you need more detailed information on components than the MiTek manual provides. Most electronic devices such as PLCs or VFDs have supplemental documentation included.

Web Site

Visit the MiTek Web site at www.mitek-us.com for up-to-date information on all MiTek equipment. View the latest revision of this manual and all Service Bulletins, find part numbers, or look up troubleshooting and other valuable resources in the Machinery section of the web site.

Contacting Us

For technical assistance or to order parts, contact the Machinery Division Customer Service Department using one of the methods listed in Figure 1-1.

Figure 1-1: Contacting MiTek

<p>MiTek Machinery Division Customer Service Department 301 Fountain Lakes Industrial Drive St. Charles, MO 63301</p> <p>Parts Orders (with part number) E-mail: mitekparts@mii.com</p> <p>Web Site www.mitek-us.com</p> <p>Technical Assistance Phone: 800-523-3380 Fax: 636-328-9218</p>	 The MiTek logo, consisting of the letters 'MI' in a large, bold, black font with three horizontal blue lines through them.
--	--

Purpose of Chapter

This chapter provides an overview of the equipment and the means to identify it.

Introduction to the Equipment

Purpose of the Equipment

The *Auto 8/10*TM Platen Press is to be used in an industrial application for the commercial production of engineered wooden roof trusses. It is to be operated by personnel specifically trained and experienced in the approved methods of engineered wooden roof truss fabrication.

Description of the Equipment

The *Auto 8/10* Platen Press is a stand-alone machine consisting of a traveling gantry head on a one-piece solid table. The truss components are positioned on the table and held in place by jiggling. The operator then moves the pressing head over each truss joint location and activates the pressing cycle. The press head is then moved to the next joint location and cycled until the truss is complete. The *Auto 8/10* Platen Press is intended as a single-stage pressing operation.

Figure 2-1 shows an *Auto 8/10* Platen Press. Refer to the Maintenance chapter for more detailed graphics.

Operating and Safety Note Highlights

- Only competent, experienced personnel with job specific training who have read and understood this manual are to operate or work near this machine.
- Do not allow anything other than wood truss components and metal connector plates to be pressed with this machine. Other objects may shatter, causing serious personal injury.
- Stand clear of all moving parts while the machine is operating. Never insert hands and arms into the pressing area for any reason at any time.
- Never press any object higher than the pressing height of the lumber. Serious damage could occur to the press and possibly result in personnel injury.

Getting the Most From Your Machine

The press is designed to be used with dimensional kiln-dried North American softwood lumber with a nominal thickness of 1-1/2" to 3-1/2". The machine will not operate properly with hardwoods and other similar dense lumber. Caution should be taken not to exceed the pressing capacity, height, or width limitations of the machine. (Refer to page 7 for specifications.)

The pressing capacity of the press is approximately 50 tons at a hydraulic pressure of 2,500 psi when in Boost Mode. The size and quantity of connector plates which can be pressed is highly dependent upon the species, density, and moisture content of the lumber; the area, style, and type of connector plates; and the surface area of the truss that the pressing platen contacts. The point at which the press no longer properly seats the connector plates is the maximum capacity of the press. Exceeding the limitations of the machine will result in the connector plate not being properly embedded which will reduce their holding capacity and therefore the strength of the truss. If this occurs, place the truss through a second-stage pressing device like a finishing press.

All lumber components must be of the same thickness. The truss must not overhang the table where the press head may hit it. Use adequate jiggling to hold the truss components securely in place to prevent movement during the pressing operation.

The travel speed of the press is preset. Never increase the preset travel speed, as the increased stopping distances will defeat the scanner and braking circuit.

Main Components and Optional Equipment

Component Overview

Table 2-1 lists the main components that comprise this system.

Table 2-1: Main Components

Component	Description
Table	Single table where truss is assembled and pressed. It has a plastic table top over a solid steel plate. See Table 2-2 for lengths and jiggling available.
Press Head	Gantry head with platen that presses plates into truss.

Table 2-2 lists the options available with this system.

Table 2-2: Optional Components and Features

Component	Description
Table Length	40' and 45' lengths are available. Other lengths may be requested.
Jiggling and Jiggling Slots Style	Choose between a J-slot jiggling slots and T-slot jiggling slots. See the <i>J-Slot vs. T-Slot</i> section for a description of both.

J-Slot vs. T-Slot

J-slot tables use J-slot jiggling. The jiggling is placed in the J-slot and can be slid to the exact location needed. The J-slot jiggling is held in place by a horizontally oriented bolt.

T-slot tables use the same *MiTek* jiggling used on other *MiTek* truss assembly tables. The jiggling is placed in any table slot and can be slid to the exact location needed. The T-slot jiggling is held in place by a vertically oriented bolt.

Technical Specifications

General Specifications

Table 2-3: General Specifications

General	
Travel speed:	5' per sec
Dimensions of system:	See page 14
Dimensions of working area:	Entire table top surface
Pressing cycle:	1-1/2 sec
Pressing height:	1" to 5-3/4"
Pressing capacity (max. nominal):	50 tons
Pressing platen:	24" wide x 1-1/2" thick <i>Width of table determines pressing area width.</i>
Motors	
Electric motor:	15 hp
Drive motors:	powered by hydraulics
Hydraulics	
Working pressure range:	1200-2500 psi (1600 psi recommended)
Boost pressure (max.):	2500 psi
Max. hydraulic pressure:	2600 psi
Hydraulic fluid reservoir capacity:	Auto 8: 45 gal Auto 10: 60 gal
Dimensions of System Components	
See Table 3-2	
Weight of System Components	
See Table 3-7	

Environmental, Transportation, and Handling Specs

Operating Temperature

This equipment will operate correctly in its intended ambient temperature, between 41 degrees and 104 degrees Fahrenheit (between +5 degrees and +40 degrees Celsius).

Relative Humidity

This equipment will operate correctly within an environment at 50% RH, 104 degrees Fahrenheit (+40 degrees Celsius). Higher RH may be allowed at lower temperatures.

Measures shall be taken by the Purchaser to avoid the harmful effects of occasional condensation.

Altitude

This equipment will operate correctly up to 3280 feet (1000 meters) above mean sea level.

Transportation and Storage

This equipment will withstand, or has been protected against, transportation and storage temperatures between -13 degrees and 131 degrees Fahrenheit (between -25 degrees and +55 degrees Celsius) and for short periods up to 158 degrees Fahrenheit (+70 degrees Celsius). It has been packaged to prevent damage from the effects of normal humidity, vibration and shock.

	ENVIRONMENTAL
	<p>Do not discard machinery into municipal waste stream.</p>

Truss Terminology

Table 2-4: Truss Terminology

Length Types	Height Types	
Overall length	H1	Board height
Centerline length	H2	Centerline height
Top length	H3	Centerline height
Bottom length	H4	Centerline height

Figure 2-1: Terminology Diagram

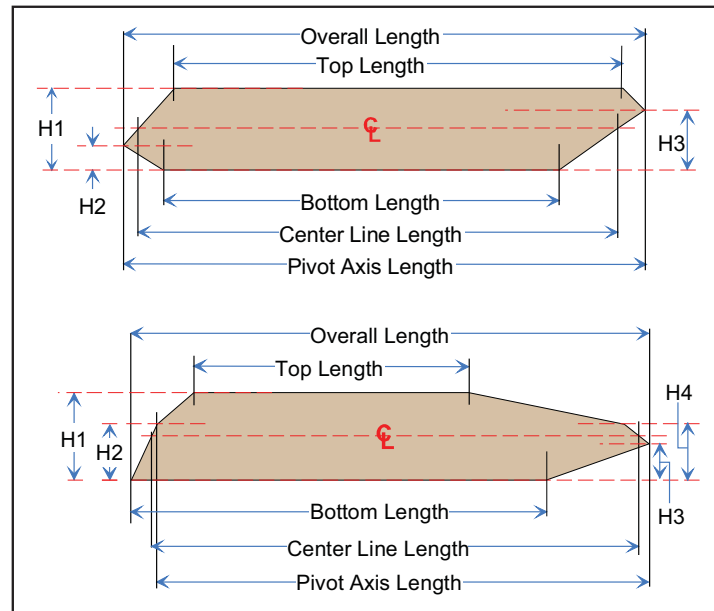
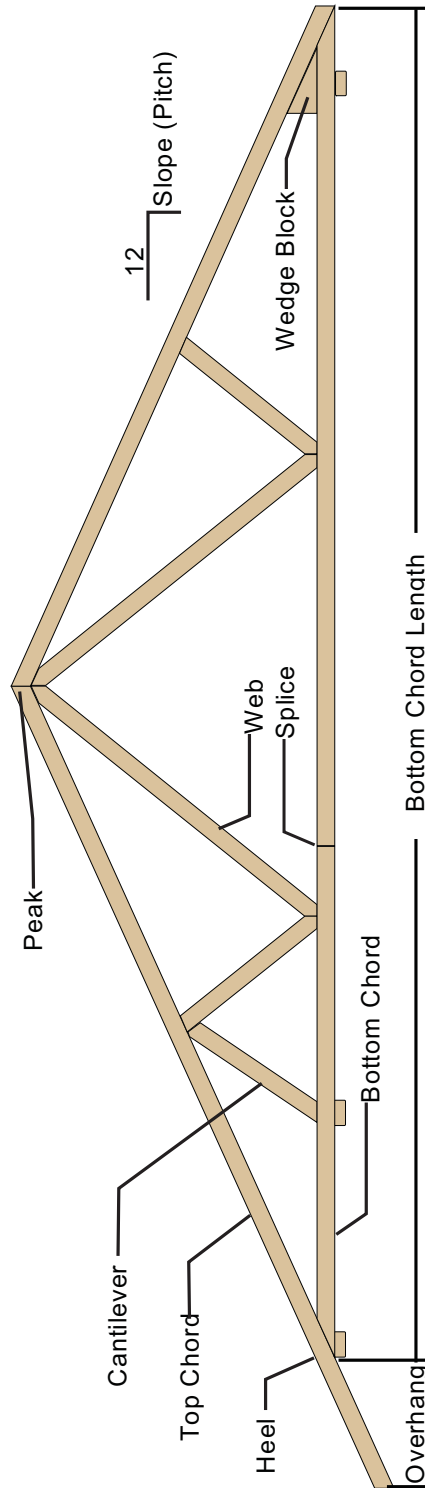

Figure 2-2: Parts of a Truss



Purpose of Chapter

This chapter covers what you must consider or complete before this equipment can be installed.

MiTek Responsibilities

Prior to Installation

MiTek will provide the following items and information prior to the installation date:

1. A Prior to Installation package that:
 - Outlines this chapter and requests a signature of agreement.
 - Gives dates to expect shipment, delivery, and installation.
 - Explains the number of people required to help with installation.
 - Provides guidelines on providing an electrician, welder, and other specialists.
 - Describes payment information.
2. A layout showing how the customer has indicated that the equipment should be arranged within the building.

During Installation

This equipment can be self-installed with the proper equipment and a qualified electrician. If preferred, it can be arranged for a MiTek Customer Service Technician (CST) to oversee the installation.

Customer Responsibilities

Before the installation of the equipment, the items and procedures in this chapter must be arranged, purchased, or assembled. Table 3-1 provides an overview of these items. Each topic listed in the table is explained in detail in the text following the table.

If these requirements are not satisfied before the scheduled installation date, it may be necessary to reschedule the installation. Any additional cost may be the customer's responsibility.

Table 3-1: Summary of Customer Responsibilities

Space Requirements	This equipment requires enough space to allow for the machine dimensions listed in Table 3-2, plus additional working space for operation and maintenance. Space should have adequate lighting.
Location Requirements	Reinforced concrete, a minimum of 6 in. thick 3,500 psi, is required to support the weight of the equipment. The equipment discussed in this manual must be used in dry conditions under a roofed area according to Type 12 electrical enclosure requirements.
Electrical Requirements	The standard electrical requirements are shown in Table 3-3. Contact your MiTek representative immediately if custom power specifications need to be accommodated.
Hydraulic System Requirements	Hydraulic fluid that meets the requirements in Table 3-5 must be available during the installation process.
Pneumatic Requirements (Compressed Air)	See Table 3-6 for pneumatic requirements, only applicable for systems with the floor truss jiggling option.
Shipping Requirements	See Table 3-7 for shipping weights.
Customer-Supplied Items	The customer is responsible for having the supplies listed in Table 3-8 available at the time of installation.
Local Codes	The customer must be familiar with all local codes that apply and ensure the equipment is installed in a way that meets these codes. See page 20 for more details.

Space Requirements

Refer to these guidelines when planning your space allocation. MiTek can provide help with plant layout and space utilization upon request.

Space for Operation and Maintenance

Additional space must be allocated for operation and maintenance. Operation space should provide safety, freedom of movement, storage space, and free flow of raw and finished materials. There must also be adequate space for safe handling of the raw and finished materials throughout the process. Refer to your layout for recommended space required.

Electrical enclosures and distribution panels must have the required amount of space clear in front of them. In the United States, regulations usually require 3 ft, but check your local regulations.

The space required is dependent on your maintenance and operating processes. The largest truss the system can create must be easily removable from the tables.

Space for the Equipment

It is the customer's responsibility to provide adequate space for the installation, operation, and protection of the equipment. The physical dimensions of the equipment are shown in Table 3-2. Additional space is required for operation, maintenance, and optional equipment.

Refer to your specific layout, provided by your MiTek representative for exact measurements. The dimensions in this manual is intended for general space planning.

Table 3-2: Approximate Equipment Dimensions

Component	Length	Width	Height (not adjustable)
Gantry Head	15' 5" (includes platform)	6' 9" (includes hard stops)	5' 9" (plus beacon)
Table	45' or 40'	8' or 10'	33-1/2" (J-slot) 34-3/4" (T-slot)

Figure 3-1: Terminology Used for Gantry Head Dimensions

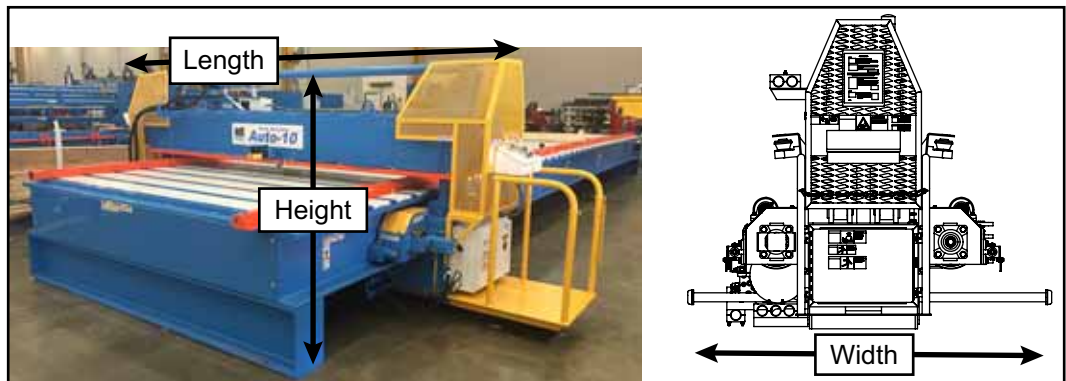
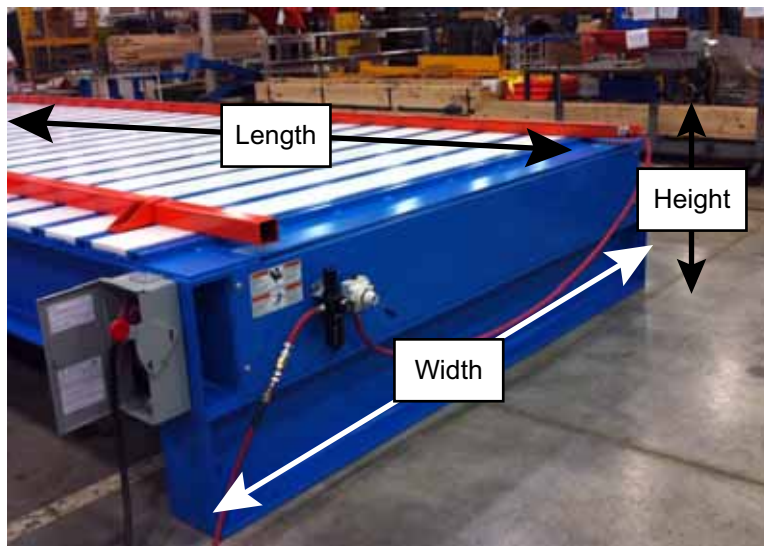

Figure 3-2: Terminology Used for Table Dimensions



Location Requirements

Floor Structure

A level and structurally sound concrete slab must be provided for the installation of the equipment. This slab should be designed and installed in accordance with local building code requirements. Reinforced concrete should be a minimum of 6 in. thick. Three thousand five hundred (3,500) psi concrete is recommended. Refer to the equipment layout drawing.

Environment

The equipment must be used in dry conditions under a roofed area according to Type 12 electrical enclosure requirements.





Type 12 enclosure definition:

Indoor Use - Primarily to provide a degree of protection against circulating dust, falling dirt, and dripping non-corrosive liquids.

Never spray the electrical enclosure with a hose.

Lighting should be adequate for safe operation and maintenance. A minimum of 323 Lux (30 foot-candles) is recommended.

Electrical Requirements

	 WARNING
	<p>ELECTRICAL HAZARD!</p> <p>All electrical work must be performed by a licensed electrician.</p> <p>Follow approved lockout/tagout procedures (OSHA 29 CFR 1910.147).</p>

The standard electrical requirements are shown in Table 3-3.

The power supply must have a fused disconnect switch, separate from the disconnect switch on the machine. The power supply line must reach the disconnect enclosure on the machine.

The customer must indicate what voltage is available at the machine’s proposed location when placing the order. This information must be correct. Depending on the voltage available, revisions to the electrical system or a transformer may be necessary.



Table 3-3: Minimum Electrical Requirements for This Equipment

Voltage	208/230/460/575 VAC
FLA Plus Control Amperage	45.4/42.2/21.1/18.9 amps
Equipment Disconnect Protection	60/60/40/30 amps
Cycles (Frequency)	60 Hz
Phases	3



Hydraulic fluid must be available for the initial charge of the machine prior to startup.

Hydraulic System Requirements

	 WARNING
	<p>HIGH PRESSURE HAZARD.</p> <p>Compressed air and hydraulic lines should be installed only by qualified personnel familiar with all governing regulations. Failure to use proper materials and installation practices can result in ruptured lines leading to personal injury, equipment damage, and equipment failure.</p>

The customer must have the proper amount of hydraulic fluid on-site during the installation of this equipment. It can not operate without the proper hydraulic fluid.

Table 3-4: Minimum Hydraulic Fluid Needed for Startup (also in *Maintenance* chapter)

Auto 8 press	45 gallons
Auto 10 press	60 gallons



Table 3-5: Hydraulic Fluid Specifications (also in *Maintenance* chapter)

Recommended Operating Viscosity Range	60-245 SUS	
Temperature	At Startup	< 68 deg. F
	During Operation	86 to 120 deg F
ISO Grade ^a	32	

- a. If operating outside of the recommended temperature range, select a hydraulic fluid that will operate at the proper SUS range for your temperatures.

	NOTICE
	<p>Starting the machine at a temperature below the minimum operating temperature rating of the fluid will cause severe damage to the hydraulic system. If needed, an in-tank submersible oil heater should be used.</p> <p>Operating the machine with oil temperature above maximum temperature allowed will cause severe damage to the hydraulic system.</p>

Pneumatic System Requirements (For Optional Floor Jigging)

	 WARNING
	<p>HIGH PRESSURE HAZARD.</p> <p>Compressed air and hydraulic lines should be installed only by qualified personnel familiar with all governing regulations. Failure to use proper materials and installation practices can result in ruptured lines leading to personal injury, equipment damage, and equipment failure.</p>

This equipment uses compressed air, also referred to as pneumatic power. Your current air compressor is probably adequate. If you need to install a new compressor, the air source must be supplied and installed prior to the scheduled installation date of the MiTek equipment. Table 3-6 describes the pneumatic system requirements.

Table 3-6: Pneumatic System Specifications

Connecting Air Source to System	Pressure
1/2" diameter tube between air source and air regulator; discuss location of air regulator with your <i>MiTek</i> representative before installation	up to 20 psi

Shipping Information

When the equipment arrives, you must have the proper transport and lifting equipment available to remove it from the truck and place it in your facility. Table 3-7 lists the weight of the individual components of a typical system.



	 WARNING
	<p>Transport and lifting equipment such as forklifts and cranes must be designed and rated for the load and application. The weight of each major component is given in Table 3-7.</p> <p>Inadequate transport equipment may result in property damage, personal injury, or death.</p>

Table 3-7: Approximate Shipping Weights

Contents of Shipment	Auto 8	Auto 10
	lb	lb
Gantry head	12,000	15,000
40-ft table	25,000	28,000
45-ft table	27,000	30,000

Customer-Supplied Parts

The customer must supply the parts shown in Table 3-8. Some must be installed before installation of the equipment and some must be available for use at the time of installation.

Table 3-8: Customer-Supplied Parts

Item	When Needed	Description	
Compressed Air <i>(For optional floor jiggging only.)</i>	Installation date	Supply line from air compressor to air regulator that meets the requirements in Table 3-6 Air compressor that can meet the requirements in Table 3-6 Air hose to reach from air source to 1/2" NPT port on the air regulator (1/2" coupler and hose clamp are supplied)	
Electrical Equipment	Prior to installation date	All electrical requirements to provide power to the disconnect enclosure on the <i>Auto 8/10</i> table are the customer's responsibility	
Transport Equipment	At delivery and possibly at installation date	Two (2) heavy-duty forklifts are required to move the equipment during unloading and placement of the machine. Chains and an overhead crane rated appropriately for the weight may also be used. All transport and lifting equipment must meet the requirements given in the <i>Shipping Information</i> section	
Tools That May Need to be Rented	Installation date	Industrial hammer-drill	
General Tools:			
OHM/Voltmeter	Hammer	Hearing Protection	Anti-Seize Compound
Safety Glasses	Lock & tag	Brass Brush	<i>Loctite</i> ® #262 (Perm.)
2 lb. Hammer	Pipe Clamp	Channel Lock Pliers	<i>Loctite</i> #242
Screwdriver Set	Pry Bar	Combination Pliers	Non-Flammable Solvent
Tape Measure	Vise	2 Hydraulic Bottle Jacks	6" Vernier Caliper
Hex Key Set	Level	Lifting Chain	Torque Wrench 250 ft lb
Grease Gun	Air Nozzle	Set of Punches	Socket Set up to 1-1/4"
Straight Edge	String Line	Hand drill and drill bit set	Combination Wrench Set up to 2"
Electrical Tape	Brass Drift	16" Pipe Wrench	Adjustable Wrenches (16" and 24")
Feeler Gauge	Teflon Tape	Sledge Hammer	
Work Gloves		Snap Ring Pliers	

Local Codes and Regulations

The customer must be familiar with all local codes that apply and ensure the equipment is installed in a way that meets these codes. The following list identifies some, but not all of the items that should be discussed with local authorities.

- Equipment should be stable under all conditions of use, including seismic events
- Fuse and disconnect regulations
- Grounding and emissions regulations
- Space required
- Personal protective equipment required
- Inspections required

Training Provided

If MiTek is overseeing the installation of your equipment, the MiTek representative trains the operators and maintenance personnel on the proper operation and maintenance of the equipment. The representative explains the warranty policy, gives an overview of the equipment manual, and requests the signature to verify the understanding of everything discussed.

If a MiTek representative is not required to be present, it is your responsibility to ensure all necessary personnel read the Equipment Manual and address all guidelines and safety instructions given.

Delivery

Checking for Damage

All shipments from MiTek are covered with tarps. When the shipment arrives, check to ensure that the tarps are in place. Displaced tarps might indicate a potential problem.

After removing the tarps, inspect the shipment for water/moisture, debris, and damage. Report any findings as required by the transport company. Document any findings by taking photographs or a video. Note any and all damage to the equipment on the bill of lading to ensure proper documentation for insurance claims. Without this note, any damage in transit is the responsibility of the customer to repair.

Notify MiTek Machinery Division Customer Service of any unacceptable findings discovered during the receipt inspection. Although your findings might not appear to be a problem, they might cause premature failure of components, poor performance, or erratic performance.



See page 18 for the weight of each component.

Unloading

Refer to the *Prior to Installation* chapter for information regarding preparing for the delivery.

Even if a MiTek representative is present, it is the responsibility of the customer to provide equipment and labor for unloading, placement, and wiring of the equipment. A heavy-duty forklift or truck wrecker is required to move the equipment during unloading and placement of the machine. The lifting equipment must be rated appropriately for the weights shown in Table 3-7 on page 18.

Exercise extreme caution to avoid damage or misalignment during unloading. Do not apply pressure on any moving parts or fittings. Figure 3-3 shows how to lift and move the equipment safely.

 WARNING	
 	<p>CRUSH HAZARD.</p> <p>Failure to lift the equipment in the prescribed manner may cause serious injury, including death, or equipment damage.</p> <p>Personnel not involved in the off-loading from the truck shall remain clear of the area.</p> <p>Transport and lifting equipment such as forklifts and cranes must be designed and rated for the load and application.</p>

Unloading the Press Head



NOTICE	
	<p>Be careful not to damage safety shut-off bars, pressing guards, or the hydraulic and electrical components.</p>

Figure 3-3: Place Forks Under Platen to Lift Gantry



Unloading the Table Using a Forklift



1. To lift the table, use two forklifts positioned across from each other, one on each side of the truck trailer and centered along the length of the table.
2. Move the forks of both fork trucks under the rail of the table and lift the table about 12" above the trailer.
3. Have the truck pull forward to move the trailer out of the way.
4. Lower the table to the ground slowly.
5. Reposition the forklifts at the ends of the table, with the forks under the table base.

Unloading the Table Using Chains

If using chains and an overhead crane to lift the table, refer to Figure 3-4.

Figure 3-4: Lifting the Table With Chains and Crane

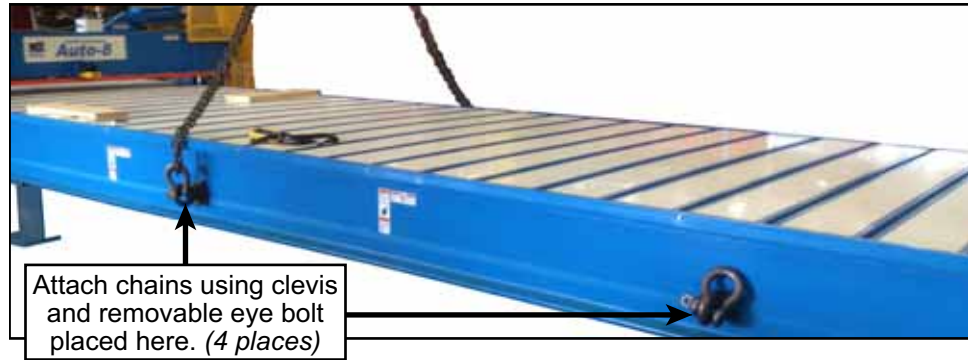

Purpose of Chapter

This chapter describes the entire installation process in detail. The instructions assume that the prior-to-installation requirements are satisfied.

Responsibilities During Installation

This equipment can be self-installed with the proper equipment and a qualified electrician. The customer is responsible for providing all labor and equipment needed to complete the installation. These requirements are explained in the *Prior to Installation* chapter.



All customer responsibilities before and during installation are described in the *Prior to Installation* chapter!

General Installation Requirements

Machinery Location

The equipment is typically located inside the building and parallel to a wall. Usually, all trusses are built from the operator's side (front side). In this case, the back side of the table can be positioned about 48" away from the wall for access and maintenance only. If workers are using both front and back sides of the table, greater working space is required. (Refer to the Machine Layout Drawing, page 51.)

Travel Speed

The press' travel speed is preset. The operator rides on the operator's platform and directly controls the movement of the press head. Never increase the preset travel speed, as the increased stopping distances will defeat the safety shut-off bars and braking circuits.

Electrical Power

The customer must have a permanent electrical power service brought to the machine which meets the voltage and amperage requirements listed on the machine nameplate.

- Typically, power is brought to the machine from a fused disconnect switch or circuit breaker panel.
- The main power is brought to the disconnect switch mounted on the end of the table, using rigid steel conduit. This disconnect switch can be padlocked in the Off position to lockout the machine when required.
- The lower, green-colored conductor rail is used for the ground or protective earth (PE) circuit.

Hydraulic Fluid

See page 17 for hydraulic fluid specifications. The indicated amount of hydraulic fluid must be available during installation.

	ENVIRONMENTAL
	<p>Add hydraulic fluid before turning on the system. The equipment is shipped with the reservoir empty.</p>

Installation Procedure

Installing the Table and Preparing for the Head

1. Place the table in its final position, referring to the layout provided by your MiTek representative. Place the table so the buss bar under the table aligns with the operator end of the gantry head.
2. Determine which end of the table will be used for placing the gantry head.



The head must be installed on the end of the table without the electrical disconnect switch or mounting brackets.

Ideally, it is best to install the head of the machine on the left-hand end of the table (when looking at the operator dashboard), as this allows the pump rotation and hydraulics to be checked easily.

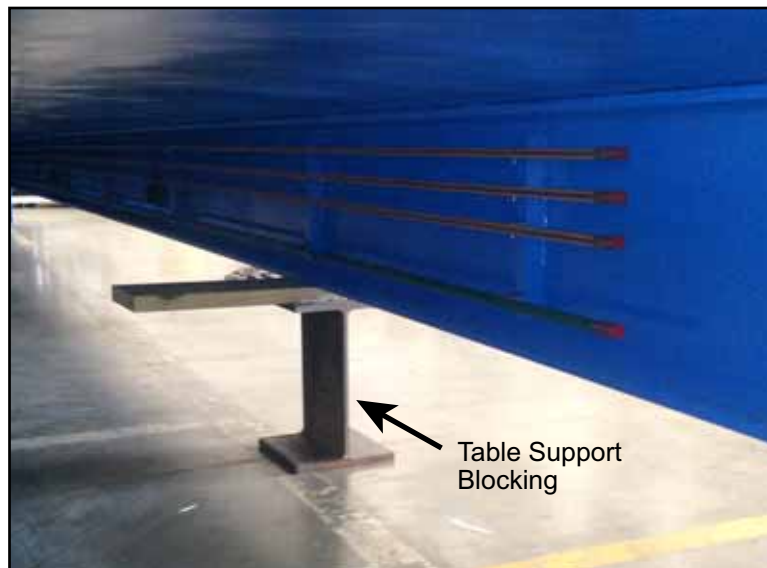

3. Mark each of the table beams with a chalk or felt pen at 8 feet in from the left-hand end of the table. This is where the temporary blocking will be located.
4. Raise the left-hand end of the table off the ground by lifting under the table base.

Figure 4-1: Supporting the Table During Installation



5. Have a co-worker place the table support blocking under each beam at the 8-foot position previously marked.

- Lower the table so that it is safely supported by the blocking, and back the forklift out of the way.

	 WARNING
	<p>Never reach underneath the table while it is being lifted by the forklift or when it is resting on the supports.</p> <p>Never lift the table by placing the forks of the forklift under the 1/2" table top plate.</p> <p>Do not place beam supports more than 8 feet from the end of the table. The weight of the head will cause the opposite end of the table to lift.</p>



- Remove the table end cover from the left-hand end of the table.
- Reposition the forklift forks under the left-hand table base for support as described on page 22.
- Remove the eight bolts which fasten the table base to the two main beams of the table.
- Remove the table base with the forklift and place it out of the way.

Installing the Gantry Head

1. Carefully tie the four electrical collectors to the table roller support so that they are not damaged when placing the head on the table.

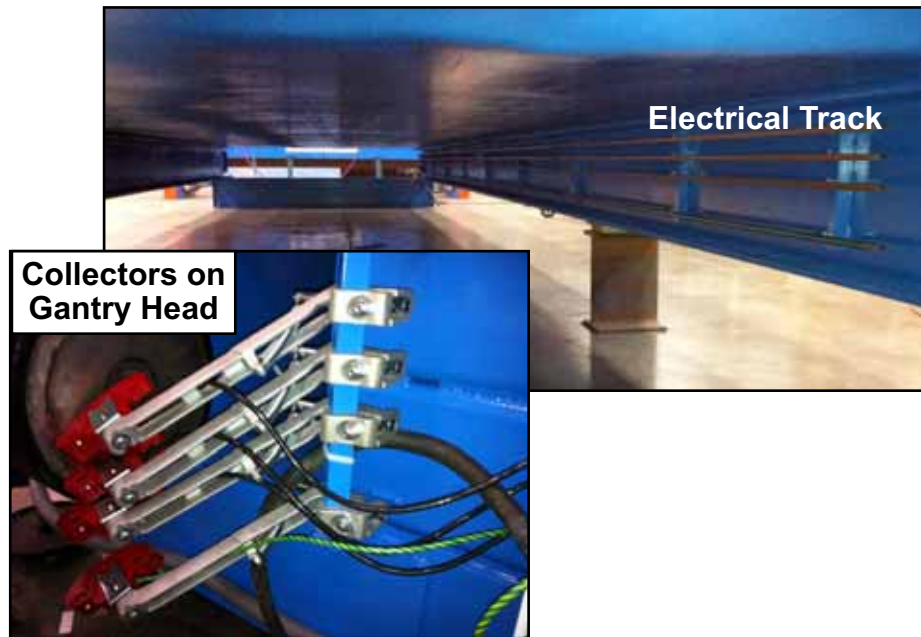
Figure 4-2: Electrical Track and Collectors



	 WARNING
	<p>Keep arms and fingers clear when placing the gantry head onto the table.</p> <p>Do not attempt to hold the collectors with your hands. Instead, tie the collectors to the table roller supports.</p>

2. Place the gantry head onto the table from one end.



The dashboard side of the press head goes to the side of the table where the electrical conductor rails are mounted (front side).



- a) Using a fork truck with enough capacity, and with the forks at their widest position, center the forks underneath the top platen and slowly lift the press head.
- b) Carefully guide the fork truck until the wheel gussets of the press are in line with the table beams, then slowly drive forward to place the press onto the table.

- c) Push the press head far enough onto the table so that the table base can be replaced.
 - d) Slightly lower the forks and back the fork truck away from the press head.
3. Using a fork truck, reposition the table base and bolt it back onto the table beams.





The weight of the press may cause the table beams to spread outward so that the bolt holes for the base become misaligned if the holes were already drilled in the concrete. Use a pipe clamp or pry bar to align the holes.

4. Lift the end of the table, with the fork truck forks placed under the beams, and remove the supports. Slowly lower the table to the ground.

	 WARNING
	Never reach underneath the table or touch the electrical conductor rails without first turning off and locking out the electrical power.

5. Connect electrical power by following these steps:

	 WARNING
	Do not climb under the table while on temporary supports! The table must be flat on solid concrete.

- a) Climb underneath the table on the right-hand side of the head and undo the strap holding the collectors.
- b) Position each pickup arm into the corresponding electrical conductor rail which is mounted on the inside of the table beam. Check that the collectors move freely on the conductor rails.

The lower, green-colored conductor rail is used for the ground or protective earth (PE) circuit.

- c) Have a qualified electrician bring power from the shop breaker panel to the disconnect enclosure on the table, in accordance with local electrical codes.

	⚠ DANGER
	<p>ELECTRICAL HAZARD!</p> <p>All electrical work shall be done by a qualified electrician and shall conform to all regulating codes. In the event that information in this manual conflicts with local code requirements, please contact MiTek Machinery Division Customer Service.</p> <p>Do not turn on electrical power until you have read the startup procedure. Follow approved lockout and tagout procedures in accordance with OSHA 19 CFR 1910.147.</p>

Figure 4-3: Disconnect Enclosure



Pneumatic System

This equipment uses compressed air (pneumatic power) for the optional floor truss jiggling. Your current air compressor is probably adequate. If you need to install a new compressor, the air source must be supplied and installed prior to the scheduled installation date of the MiTek equipment. Refer to pneumatic requirements on page 18.

Anchoring to the Floor

The table bases must be bolted to the concrete floor to prevent the machine from moving and damaging the electrical supply line. This will also reduce the bounce in the table. Fasten each table base to the floor by using the supplied wedge anchors, 2 in each table base, using the pre-drilled holes.

Figure 4-4: Install Anchors in 2 Anchor Holes on Each End



Marking Restricted Zone

Marking Area On Your Own

The restricted zone must be marked so everyone near the equipment can clearly see the area where danger may exist. MiTek offers Restricted Zone Tape with text in English and Spanish. If your equipment did not come with restricted zone tape, you may order it from MiTek Machinery Division Customer Service. The part number is listed in the *Parts List*.

You may choose to mark the restricted zone using alternative means but following these guidelines.

Installing Tape Purchased From MiTek

Cleaning the Floor

Before installing the restricted zone tape, clean the floor thoroughly to ensure the adhesive properly sticks to the floor.

1. Sweep the floor around the machine where the tape will be applied.
2. Mop the floor where the tape will be applied.
3. Wait for the floor to dry completely before continuing the procedure.

Marking Tape Location

1. Beginning at a corner of the machine on one end, measure outward 3 ft.
 - If marking around a gantry, run the gantry to one end of the line and mark outward 3 ft from the gantry platform.
 - If marking around a piece of equipment that does not have a marking layout included, mark outward 3 ft from the machine.
2. Make a mark on the floor at the proper location.
3. Repeat steps 1 and 2 for each corner of the machine.
4. Using a chalk line, make a line on the floor that connects the marks made in steps 2 and 3.



The person pressing the tape to the floor may want to wear gloves.

Placing the Tape

1. Peel the backing off of the end of the tape.
2. Place the end of the tape with the wording facing out at an outside corner of the chalk line.
3. Press the tape firmly onto the floor. Ensure all bubbles and wrinkles are out to get the best adhesive retention.
4. Continue to remove the backing, unroll the tape and press it firmly onto the floor until the entire perimeter has been marked with tape.
5. Remove the lockout/tagout devices and restart the machine.
6. Train all employees who work in the facility to stay outside the tape when the machine is operating.

	 DANGER
	<p>ELECTROCUTION, HIGH PRESSURE, AND CRUSH HAZARDS!</p> <p>Do not attempt to start the system without a MiTek representative present!</p> <p>Serious injury and/or equipment damage may result.</p>

Purpose of Chapter

This chapter describes the procedures required before operating your equipment.



The equipment is shipped with the hydraulic fluid reservoir empty. Add fluid before turning equipment on!

Preparing for Startup

1. Check all hydraulic hose connections to ensure that the fittings have not worked loose during shipping.
2. Check over the entire machine to ensure that all guards, inspection plates, fasteners, oil tank covers, and caps are secure.
3. Check air hoses and all pneumatic components, if equipped.
4. Check all electrical connections.
5. Check that the motor overloads are set to Manual. See page 135.
6. Secure hydraulic and electrical lines off the floor to avoid trip hazards.

Figure 5-1: Securing Hoses Off Floor





Preparing the Hydraulic System

Filling the Reservoir With Hydraulic Fluid

Fill the hydraulic reservoir with hydraulic fluid that matches the specification listed on page 17. Ensure that the required amount of hydraulic fluid is available prior to planning the startup.



Fill the reservoir within 2 in. from the top. Watch the sight gauge on the reservoir to determine the fill level. Refer to page 71 in the *Maintenance* chapter for instructions on filling the reservoir.

	 CAUTION
	SLIP HAZARD. Do not overfill. Clean up any spillage immediately to avoid injury.

Priming the Pump

Follow the procedure in the *Priming the Pump* section on page 88 to prime the pump before operating the equipment.

Checking Motor Rotation

	 DANGER
	<p>ELECTRICAL HAZARD!</p> <p>All electrical work shall be done by a licensed electrician and shall conform to all regulating codes. In the event that information in this manual conflicts with local code requirements, please contact MiTek Machinery Division Customer Service.</p> <p>Do not turn on electrical power until you have read the startup procedure. Follow approved lockout and tagout procedures in accordance with OSHA 19 CFR 1910.147.</p>



Check the motor rotation of the hydraulic system motor to ensure it is rotating in the same direction as the arrow on its housing:

1. With the table end cover off, locate the hydraulic system's electric motor.
2. Ensure all personnel are out of the restricted zone and are aware that the machine is going to start.
3. Turn on the power at the shop circuit breaker and at the table disconnect switch.
4. Turn the control power key switch to the On position.
5. Have a worker press the START button, and then the STOP button immediately afterwards. The rotation of the drive coupling must match the rotation arrow marked on the pump.
6. If the rotation is in the reverse direction, swap two of the three-phase connections. The pump and motor should rotate clockwise as viewed from the back end (fan end) of the electrical motor.



Safety Tests

Perform the test(s) on page xxi in the *Safety (English)* section before operating equipment!



	 WARNING
	<p>CRUSH HAZARD!</p> <p>Perform the safety test(s) before operating the equipment at the initial startup, after performing any maintenance, and in accordance with the maintenance schedule</p>



Purpose of Chapter



This chapter describes the operating mechanisms on this equipment and the procedure to operate it in most circumstances.





Before You Begin

Safety Operating Notes

	 WARNING
	<p>ELECTROCUTION, HIGH PRESSURE, AND CRUSH HAZARDS!</p> <p>Read this section AND the safety section in the preliminary pages before operating or maintaining this equipment.</p> <p>Do not operate this machine until you have a thorough understanding of all controls, safety devices, E-stops, and operating procedures outlined in this manual.</p> <p>Read and observe all warnings. Failure to do so may result in economic loss, property damage, and/or personal injury.</p> <p>This manual must always be available to personnel operating and maintaining this equipment.</p>

	 WARNING
	<p>CRUSH HAZARD.</p> <p>Before turning on the equipment, make sure that all personnel and equipment are out of the restricted zone (see page xix).</p>

	 WARNING
	<p>Do not operate unless all guards and safety devices are in place.</p> <p>Only qualified maintenance personnel shall repair, remove, or replace guards and safety devices.</p>

	 CAUTION
<div style="display: flex; flex-direction: column; align-items: center; justify-content: center;">    </div>	<p>The operation of this equipment requires the use of PPE.</p> <p>Do not operate without wearing required protective clothing.</p>

Stopping and Moving the Machine in an Emergency

Emergency Stop (E-Stop) Methods

The procedures listed here activates the emergency stop circuit or turns off the power to the electronic safety module. If moving, this will cause the machine to stop abruptly.

Do not use the E-stops as a standard stopping method during the operation procedure. Overuse will cause certain components to wear faster. Use the controlled stopping methods discussed on page 43 for normal operational stopping. After utilizing an emergency stop method, inspect the hydraulic system for leaks before using the machine.

PN





Upon using an E-stop pushbutton or scanner, the seals below the hydraulic valve may have extruded from their seat. Inspect the system carefully and order the seal kit listed in the Parts List if needed.

1. **Emergency Stop (E-Stop) Pushbuttons:** When an E-stop button is activated, the system waits 2 seconds allowing the platen to return to the Up position, then the electric motor loses power. They are located on the...
 - Dashboard (Dashboard E-Stop)
 - Non-operator end side of the press head (Head E-Stop)
2. **Scanner:** A scanner located on each side of the press head provides constant surveillance of the area directly in front and off the ends of the press head. These areas have been protected by pressing guards and pushbars on previous generations of this equipment. The scanner automatically comes on when the Control Power key is turned on. It is part of the E-stop circuit.

See page 128 for an overview of what happens when the scanner detects an obstruction. See page 61 for restarting the machine after a scanner is activated.

3. **Control Power Key Switch:** Turn the control power key switch on the control dashboard to the Off position to cease control power to the machine.
4. **Electrical Disconnect Switch:** Turn the electrical disconnect switch on the end of the table to the Off (Down) position.

	 WARNING
	<p>ELECTRICAL HAZARD!</p> <p>When the disconnect switch is off, there is still live power to the disconnect switch's enclosure. Always lockout/tagout power at the main power source before opening electrical enclosure!</p>

Note the different types of E-stops and their locations shown in Figure 6-1. Each is described further in the text.

Figure 6-1: E-Stop Locations



Manually Moving the Press Head or Platen

If the platen or press head must be moved manually, either for maintenance or to free an obstruction, follow the procedures in this section.

Moving the Press Platen and Linkage

If the platen must be moved manually, follow this procedure:

1. Wrap rags around the two hydraulic hoses connected to the pressing cylinder to contain the potential spray of oil.
2. Loosen the hose fittings with a wrench to release the trapped oil.
3. Pry on the pressing platen or the press linkage with a pry bar to move in the direction required.

Figure 6-2: Disconnect These Hoses From Cylinder

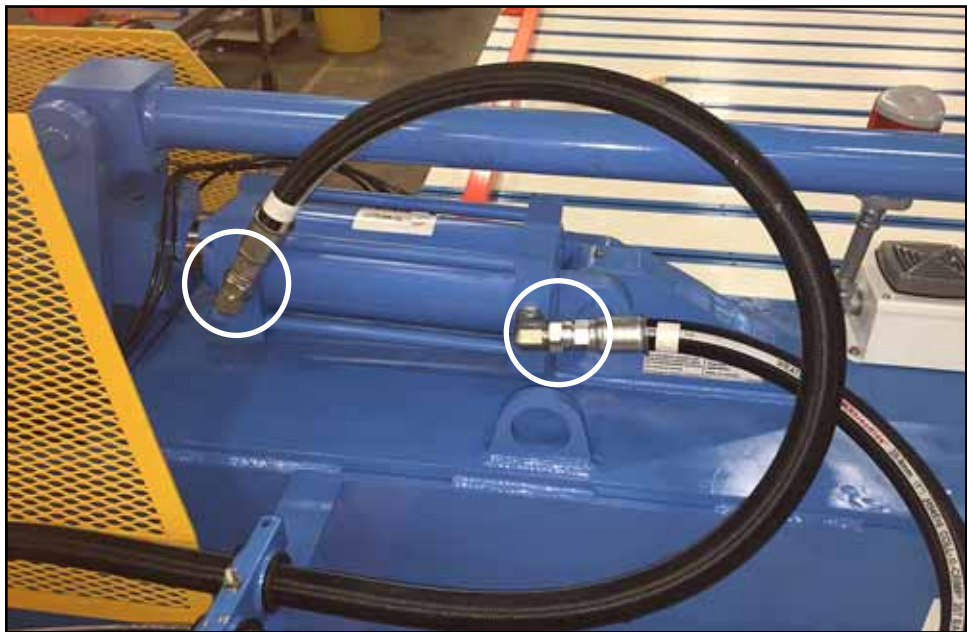

Moving the Press Head Along the Table

If the press head must be moved on the table manually, follow this procedure:

1. Wrap rags around the 2 hydraulic hoses connected to the drive motors (1 on each end) to contain the potential spray of oil. The hoses for 1 motor are shown in Figure 6-3.
2. Loosen the hose fittings with a wrench to release the trapped oil.
3. Pry or push on the machine head in the direction in which it is to be moved on the table.

Figure 6-3: Remove Hoses From Drive Motors

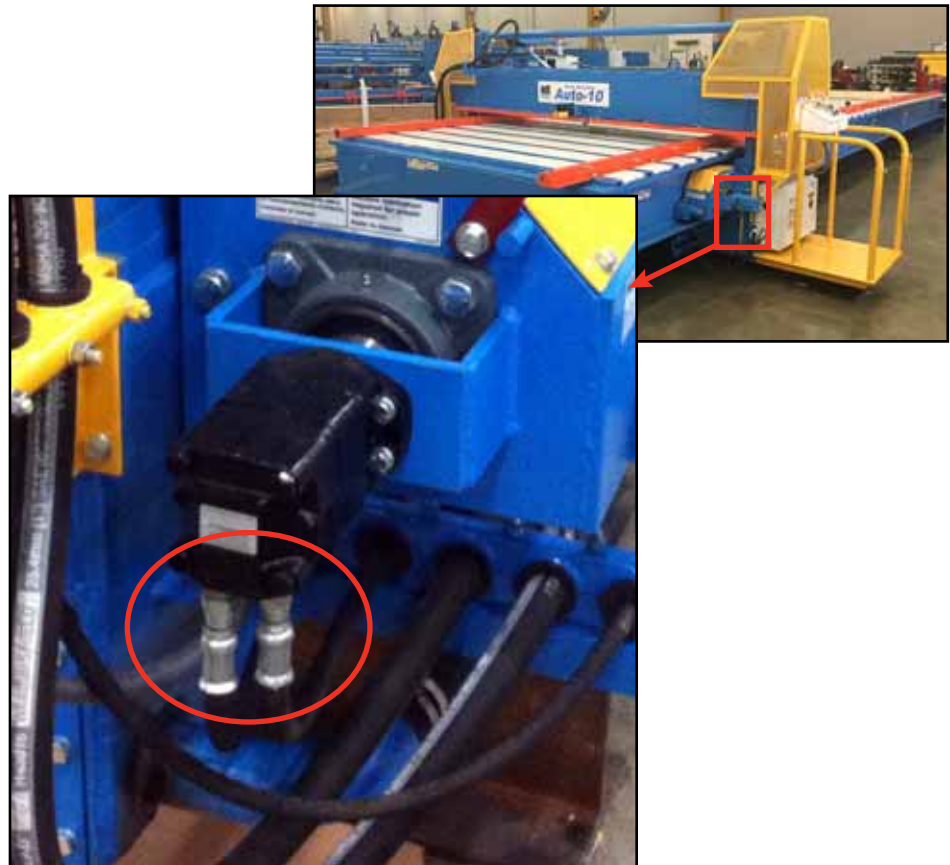

Controlled Stop Procedure



Controlled stop mechanisms are shown on page 44

The procedure listed below will only turn off the control power or power to the valves. If traveling, the machine will coast to a stop within the normal distance.

1. STOP Button

Press the STOP button located on the control dashboard to stop the machine.

2. Joystick

Release the Right or Left travel joystick, if activated, to stop the travel mode.

Move the joystick to the Up position to stop the downward movement of the platen and return the platen to the raised position.

Note the different types of E-stops and their locations shown in Figure 6-1. Each is described further in subsequent text.

How Stopping Works

During a controlled stop, the cushion valve reacts, causing the gantry head to coast to a stop. When an E-stop is used, all hydraulic fluid motion is ceased putting great pressure on the valves and seals, and causing the gantry head to stop much faster.

Starting the Machine

Refer to page 49 for the operating procedure.

Operator Control Interface and Dashboard

Figure 6-4: Overview of Control Mechanisms on Dashboard

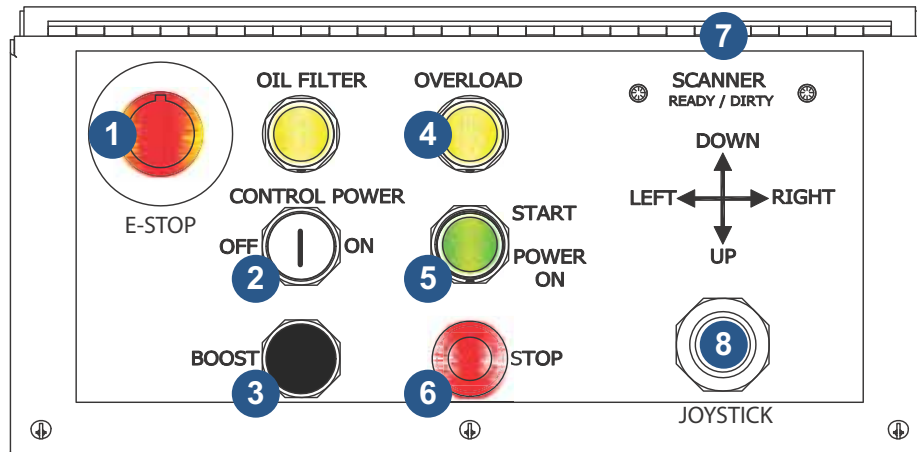



1. Emergency Stop pushbutton on the dashboard

An Emergency Stop pushbutton is located on the dashboard. Press the Emergency Stop pushbutton to turn off the machine and activate the travel braking circuit. This Emergency Stop pushbutton is hard wired into an electronic safety module to provide a Category 0 emergency stop function when depressed. All Emergency Stop pushbuttons must be in the Out position and properly functioning in order for the machine to be started.

2. Control Power key switch

This key switch turns the control power on and off. Turn the key to the right (On position) to allow the control circuit to be started. Turn the key to the left (Off position) and remove it to prevent accidental starting or unauthorized use of the machine. Always turn the key to Off and remove it when setting up the jigs, if personnel are in a hazard zone, when performing maintenance, and at the end of the work day.

 WARNING	
	This switch controls only the control circuit power. Be sure to turn off and lock-out the main electrical power feeding the machine before opening the electrical enclosure. Only a licensed electrician should perform any electrical work.

3. Boost button



The Boost function has a 10% daily duty cycle. Exceeding this duty cycle will cause premature wear of the mechanical and hydraulic components.

The press is designed with the following pressing cycles:

- a) Normal pressing cycle
 - Generates between 24 and 36 tons of pressing force.
 - 90% of all pressing must use the Normal pressing cycle.
 - Should be used on most small connector plates.
- b) Boost pressing cycle
 - Generates up to 50 tons of pressing force.
 - Less than 10% of all pressing should use the Boost pressing cycle to prevent premature wear on components.
 - Should be used only to seat large connector plates which will not be properly seated using the normal pressing cycle. If the connector plates are not properly seated using the Boost pressing cycle, the maximum capacity of the press has been exceeded.

When this button is pressed during the pressing cycle, it overrides the pressure switch which normally initiates the platen release, allowing the system tonnage to reach up to 50 tons before raising the platen. Use the Boost function only when absolutely necessary for seating larger connector plates.



To activate the Boost function, first activate the joystick to the Down position. While holding the joystick in the Down position, press and hold the BOOST button until pressing is complete.

4. Overload light

Indicates an overload fault. See page 135 for resetting the overload.

5. Start button

Press this button to turn on the electrical control power and start the electric motor and pump.

	 WARNING
	<p>CRUSH HAZARD.</p> <p>If the platen is down, it will automatically return to the up position when the machine is started.</p>



Both scan areas must be free of obstructions and the E-Stop buttons must be in the Out position in order for the electric motor to be started.

6. Stop button on the dashboard

A STOP button is mounted on the dashboard. Pressing this button turns off the control power to the machine which stops the hydraulic power pack. All functions of the machine will halt. If the machine is traveling, it will coast to a stop.

7. Scanner (Ready/Dirty)

The Scanner indicator lights communicate two states that the scanners could be in. The light on the left is for the left-side scanner and the light on the right is for the right-side scanner. When the light is green, that scanner is ready to do its job. When the light is red, that scanner sensor is dirty, or there is a problem somewhere else in the system rendering the scanner inoperable. It may simply be that the system needs to be reset by pressing the START button.

8. Joystick

The joystick has four positions as described here:

- a) Right travel position: Move and hold the joystick to the right to travel the press to the right. Release the joystick just before the pressing head reaches the desired stopping position as it will coast for a short distance.
- b) Left travel position: Move and hold the joystick to the left to travel the press to the left. Release the joystick just before the pressing head reaches the desired stopping position as it will coast for a short distance.
- c) Normal pressing cycle position: Move the joystick to the Down position and hold it to cycle the platen. The platen will move down, press the truss, and return to the up position automatically when the pressure setting is reached. Continue holding the joystick down until the platen begins upward movement.

If maximum pressure is required, activate the Boost pressing cycle sequence while the platen is moving down. See page 45.

- d) Up platen position: The Up position of the joystick interrupts the automatic pressing cycle and returns the pressing platen to the Up position. Move the joystick to the Up position to stop the downward travel of the platen, in the event that a connector plate has moved or for safety reasons.

9. Emergency Stop button on back side of press head

An E-Stop button is located on the back side of the gantry head. See page 40 for the location. Depress the E-Stop button to turn off the *Auto 8/10* and activate the travel braking circuit. This E-Stop button is hard wired into an electronic safety module to provide a Category 0 emergency stop function when depressed.



Be sure to center the pressing head directly over the connector plate to be pressed. The Down cycle can be stopped by activating the joystick to the Up position.

Building a Roof Truss



The following procedures are to be used as general guidelines for setting up and manufacturing trusses. Always use current procedures and standards when manufacturing trusses.

Setting Up a Roof Truss on a T-Slot Table Top



Table 6-1: Items for Setting up a Truss on a T-Slot Table Top

From MiTek (PN 010191 & 010165)	Customer-Supplied
Wrench, customized 010105	Hex Key or T-Handle
Plate Stops	Square
Straight Stops	String Line
Heel Stops	Tape Measure
T-Stops	Engineered Truss Drawing
Pucks	
Nuts and Bolts for Each	

Machines equipped with the T-slot table tops have 1/2" UNC threaded holes on a 6" x 6" grid, designed to use with standard *MiTek* jiggling hardware.

1. Turn the control power key switch to the Off position and remove the key to prevent unauthorized use of the machine while the truss jiggling is being set up.
2. Lay out the truss components on the table, as per the engineered truss drawing. Never let a board extend past the edge of the table.
3. Position the jig hardware over the closest threaded hole. Use a jig bolt of the correct length and a jig washer, to secure the jig hardware. Tighten the jig bolt with a hex key or T-handle. Use two bolts in each slotted stop to prevent rotation.
 - Use right-hand and left-hand heel stops to locate the ends of the bottom chords. The tab on the end of the heel stops should engage the heel cut.
 - Position backing angles along the bottom chord of the truss. Use a string line to achieve straightness or to set a camber. The diagonal bolting slots in the backing angles are to allow for camber.
 - Use pucks at each joint to locate top chords.
 - Use slotted stops or pucks to position web members.



The locator blocks have a top and a bottom surface. Position the locator block so that the locking bolt is closest to the top surface of the table.

NOTICE	
	Always use the correct bolt length and jig washer (if required) with each piece of jig hardware. Serious damage will occur if bolts extend below the table top.

Setting Up a Roof Truss on a J-Slot Table Top

Table 6-2: Items for Setting up a Truss on a J-Slot Table Top



From MiTek (PN 30223-601)	Customer-Supplied
Pucks	3/4" Combo Wrench
Heel Stops	Hex Key or T-Handle
Slotted Stops	Square
Backing Angles (Slotted)	String Line
Locator Blocks (1x4" and 1x5")	Tape Measure
Slot Fillers	Engineered Truss Drawing
Bolts and Washers for Each	



Machines equipped with the optional J-slot table top have slots to hold the jiggling in place. They require J-Slot jiggling that screws into locator blocks.

1. Turn the control power key switch to the Off position and remove the key to prevent unauthorized use of the machine while the truss jiggling is being set up.
2. Lay out the truss components on the table, as per the engineered truss drawing. Never let a board extend past the edge of the table.
3. Position the jig hardware above the closest slot in the table top. Place the locator block into the slot. Using a 3/4" wrench, tighten the locator block bolt by turning it counterclockwise.
 - Use the longer, 5" locator block for the backing angles and heel stops.
 - Use the 4" locator block for the puck and slotted stops.
4. Place slot fillers into slots below the connector plates to facilitate pressing.



The locator blocks may be left in position for frequently made trusses if the jig bolt is removed from the locator block.

Pressing a Roof Truss

	 WARNING
	<p>Never reach under the table for any reason without first turning off and locking-out the electrical power. The electrical conductors mounted inside the table frame carry high-voltage electricity and will cause severe injury or death if contacted.</p>

Preparing to Press a Roof Truss



1. With the truss components securely in position, locate connector plates over and under the joints in the correct orientation, as indicated on the engineered truss drawings.
2. Ensure that there are no tools on the table and that the travel area is clear of lumber and other debris.
3. Step onto the operator platform using the handrails for assistance. Do not use the joystick as a hand hold.
4. Turn the control power key switch to On position.
5. Press the START button on the control dashboard to activate the hydraulic pump. The START button turns green when it is activated.

Figure 6-5: Hold Handrails for Support, NOT Joystick



All obstructions must be out of the scanner area and the E-stop buttons must be in the OUT position, in order for the press head to be started.

Pressing Roof Truss Plates



	 WARNING
	<p>CRUSH HAZARD.</p> <p>Before turning on the equipment, make sure that all personnel and equipment are clear.</p> <p>If the platen is down, it will automatically return to the up position when the START button is pressed.</p>



Be sure to center the pressing head directly over the connector plate to be pressed. The Down cycle can be stopped by activating the joystick to the Up position.



1. Before moving the press head, grasp the hand-hold bar with your free hand and brace your legs for balance. Look in the direction of travel and use the joystick to move the press head directly over the first connector plate.
 - Move the joystick to the right to make the press head travel to the right.
 - Move the joystick to the left to make the press head travel to the left.
 - The press head will coast for a short distance after the joystick is released. Learn to judge this distance so that the press head will stop when it is centered directly over the connector plate
2. To start the normal pressing cycle, push the joystick away from you to the Down position and hold. The platen will move down, press the truss, and return to the up position automatically when the pressure setting is reached.
3. Release the joystick once the platen begins its upward movement.
4. If the Boost feature is required, complete these steps. To understand the Boost function better, see page 45.
 - a) Depress the BOOST button while the platen is moving downward.
 - b) Hold the BOOST button in for approximately 1 second after the platen is fully down, to allow the hydraulic pressure to build up to maximum.
 - c) Release the BOOST button and the platen automatically returns to the Up position.

5. Travel the press to the next truss joint and repeat the previous steps. When traveling the press, be sure all workers are clear of the area and that there are no obstructions on the table, track, or floor.
6. When all the connector plates have been pressed, carefully travel the press head past the end of the jig.
7. Turn off the press by depressing the STOP button. Turn the key switch to the Off position.

	 CAUTION
	Don't step off the operator's platform until the press head has come to a complete stop.

8. Release the clamps and remove the truss from the jig.

Building Floor Trusses

	 WARNING
	<p>At no time must anyone reach underneath the table for any reason without first turning off and locking-out the electrical power. The electrical conductors mounted inside the table frame carry high-voltage electricity and will cause severe injury or death if contacted.</p>

Recommended Method of Building a Floor Truss

The fastest way to build floor trusses is to pre-plate the top and bottom chords for the next truss to be built.

1. Place a spare set of top and bottom chords next to the top and bottom chords of the truss.
2. Place the connector plates on the spare chords, in the correct locations, overhanging the air jig. These plates are seated during the pressing of the truss.
3. Remove the finished truss.
4. Rotate the two spare chords so that the connector plates are at the bottom, in their correct position.
5. Begin building the next truss using these chords.

This method ensures the lower connector plates are properly positioned and eliminates the time consuming task of placing them under each web.



The floor truss air jig is designed for building 4 x 2 floor trusses only. If 3 x 2 floor trusses are required, a 1"-thick spacer must be used under the truss components.

Setting Up a Typical Floor Truss

NOTICE	
	<p>Do not allow the machine to press on an empty floor truss jig or to otherwise hit the floor truss jig.</p>

Preparing and Installing Floor Jigging



Floor Truss Jig
String Line
Square
Truss Drawing
Compressed Air

1. Turn the control power key switch to the Off position and remove the key to prevent unauthorized use of the machine while the truss jigging is being set up.
2. If required, adjust the Up limit switch stop block to allow the pressing platen to open further to clear 4 x 2 floor truss components. The open height should be approximately 1" to 1-1/2" above the lumber.



The floor truss air jig is designed for building 4 x 2 floor trusses only. If 3 x 2 floor trusses are required, a 1"-thick spacer must be used under the truss components.

Figure 6-6: Up Limit Switch

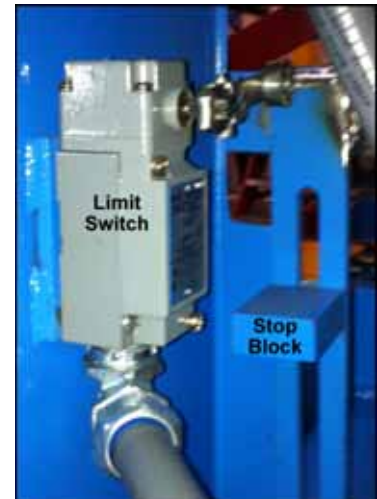

3. Install the pneumatic floor jigging:
 - a) Place two 20' sections of air jig onto the table.
 - b) Bolt down the two 20' air operated sections along the edge of the table on the operator's side. Each 1/2 x 1" bolt requires 2 flat washers and 1 lock washer. Use a string line to ensure these sections are straight.



The floor truss air jig requires 2 washers to be used with the 1" long jig bolts, in order for the bolt to not protrude beneath the table.

4. Install the backing bars with the following steps.

a) Position the backing bars:

- If pre-plating method is NOT used, place the two 20' backing bars parallel to the air sections, at a distance of the floor truss depth plus 1/4" for clearance.
- If the pre-plating methods is to be used, position the backing bars at the truss depth plus 3" for the two additional chords, plus 1/4" clearance.



EXAMPLE: For a 16" floor truss, place the backing bars at 16-1/4" spacing.



EXAMPLE: For a 16" floor truss, place the backing bars at 19-1/4" spacing.

Figure 6-7: Backing Bars

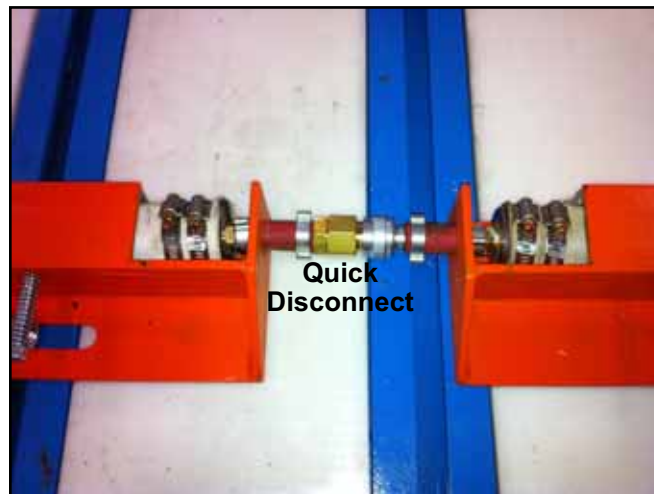



- b) Use a string line to ensure the backing bar is straight.
- c) Position the backing bar clamps along the length of the backing bar at about 4-ft intervals.
- d) Tighten the 1/2" x 1" jig bolts securing the backing bar clamps to the table.





Maximum travel of the air clamp is 1/2".

- 5. If camber is required in the floor truss, it must be put in the backing bar side using these steps:
 - a) With the ends of the backing bar securely fastened to the table, loosen the clamp bolts at the center.
 - b) With a floor truss in the air jig, and the air pressure turned completely down, activate the air clamp.
 - c) Slowly turn up the air pressure until a uniform camber is placed in the backing bar.
 - d) When the desired camber is achieved, re-tighten the backing bar clamp bolts in order to maintain this camber.
 - e) Check the camber with a string line.
- 6. Bolt the slotted stops to the table, to locate the end conditions of the floor truss.
- 7. Connect the air:
 - a) Connect the hose on the air clamp sections together and then connect the air clamp to the air control valve and regulator.
 - b) Hook up the air regulator to the shop air supply.
 - c) Adjust the air regulator to 10 to 20 psi.

	 WARNING
	<p>Do not operate the air clamp or regulator above 20 psi as it may cause the air bag to fail, possibly causing personal injury.</p>

Building the Floor Truss

1. Place the floor truss components into the air jig and arrange them as shown on the engineered truss drawing.
2. Position the connector plates as shown on the engineering truss drawing.
3. Activate the air control valve to clamp the floor truss.
4. Inspect the truss to ensure that all the joints are tight. Use the lowest air pressure that will still properly clamp the truss.

	 WARNING
	<p>At no time must anyone reach underneath the table for any reason without first turning off and locking-out the electrical power. The electrical conductors mounted inside the table frame carry high-voltage electricity and will cause severe injury or death if contacted.</p>

Pressing a Floor Truss

Preparing to Press a Floor Truss



1. With the truss components securely in position, locate connector plates over and under the joints in the correct orientation, as shown on the engineered truss drawings.
2. Ensure that there are no tools on the table and that the travel area is clear of lumber and other debris.
3. Step onto the operator's stand using the handhold bars for assistance. Do not use the joystick as a hand hold.
4. Turn the control power key switch to the On position to restore control power.



All obstructions must be out of the scanner area and the E-stop buttons must be in the OUT position, in order for the press head to be started.

Figure 6-8: Hold Handrails for Support, NOT Joystick



	 WARNING
	<p>CRUSH HAZARD.</p> <p>Before turning on the equipment, make sure that all personnel and equipment are clear.</p> <p>If the platen is down, it will automatically return to the up position when the START button is pressed.</p>



5. Press the START button on the control dashboard.

Pressing Floor Truss Plates



Be sure to center the pressing head directly over the connector plate to be pressed. The Down cycle can be stopped by activating the joystick to the Up position.



1. Before moving the press head, grasp the hand-hold bar with your free hand and brace your legs for balance. Look in the direction of travel and use the joystick to move the press head directly over the first connector plate.
 - Move the joystick to the right to make the press head travel to the right.
 - Move the joystick to the left to make the press head travel to the left.
 - The press head will coast for a short distance after the joystick is released. Learn to judge this distance so that the press head will stop when it is centered directly over the connector plate.

 WARNING	
	<p>Grip the hand hold bars when moving the machine.</p> <p>Ensure that the machine platen is centered directly over the connector plate. Off-center pressing may cause component failure, resulting in serious injury.</p> <p>If the pressing cycle must be stopped for any reason, move the joystick to the Up position or depress the STOP button, or activate either safety shutoff bar.</p>

2. To start the normal pressing cycle, push the joystick away from you to the Down position and hold. The platen will move down, press the truss, and return to the up position automatically when the pressure setting is reached.
3. Release the joystick once the platen begins its upward movement.
4. If the Boost feature is required, complete these steps. To understand the Boost function better, see page 45.
 - a) Depress the BOOST button while the platen is moving downward.
 - b) Hold the BOOST button in for approximately 1 second after the platen is fully down, to allow the hydraulic pressure to build up to maximum.
 - c) Release the BOOST button and the platen automatically returns to the Up position.
5. Travel the press to the next truss joint and repeat this procedure. When traveling the press, be sure all workers are clear of the area and that there are no obstructions on the table, track, or floor.
6. When all the connector plates have been pressed, carefully travel the press head past the end of the jig.

Off-Loading the Floor Truss

1. Turn off the press by pressing the STOP button. Turn the key switch to the Off position.

	 CAUTION
	Don't step off the operator's platform until the press head has come to a complete stop.

2. Activate the air-control valve to release the air from the air jig.
3. Remove the truss from the table.

Inspecting the Finished Trusses

All finished trusses must be inspected to confirm the proper placement and seating of the connector plates and to ensure the truss has maintained its proper configuration. Truss failure will cause serious personal injury, death and property damage. Particular attention must be paid to ensure the connector plates are fully and properly seated and have remained in the correct locations. Refer to governing national standards agency for specific regulations for wooden truss construction.



The truss must be constructed exactly in accordance with all details of the approved engineered truss drawing, using only materials certified for this use and to current industry assembly standards. Any of the following conditions may result in the improper seating of the connector plates which will reduce the holding capacity and the strength of the truss:

- Exceeding the total area of connector plates (size, quantity and plate style) which the press can embed at one time will result in the connector plates not being properly seated.
- Using lumber components of different thicknesses will result in the connector plates not being properly seated into the thinner boards.
- The truss components must be securely clamped or fastened to each other with adequate jiggling, staples or nails, to prevent separation or movement during the pressing operation.
- The connector plates must be securely fastened, stapled, or nailed to the wooded truss components to prevent movement during the pressing operations.
- If the pressing force of the machine is set incorrectly:
 - The connector plates will not be seated properly if the pressing force is to low.
 - The lumber may be damaged if the pressing force is to high.
- The lumber must be of the specified species, grade, and moisture content, as per the engineered truss drawing.
- The connector plates must be certified for a single stage pressing application. Using a non-certified connector plate will result in the teeth not being embedded properly in the lumber.

Restart Procedure

The press cannot be restarted if any of the safety circuits are activated.

1. Turn the control power key to the ON position.
2. Pull the emergency stop buttons to the Out position.
3. Ensure there are no obstacles in the scan areas.

	 WARNING
	<p>CRUSH HAZARD.</p> <p>Before turning on the equipment, make sure that all personnel and equipment are clear.</p> <p>If the platen is down, it will automatically return to the up position when the START button is pressed.</p>



If the press stopped because a scanner is activated, the gantry head can be moved in the opposite direction to facilitate the removal of the obstacle. To do so, press and hold the START button while pushing the joystick in the opposite direction.

4. Press and release the START button.
5. Move the joystick in the appropriate direction for horizontal travel.

Purpose of Chapter

This chapter provides step-by-step instructions as well as information to help you understand how your equipment works to enable you to make repairs and perform preventive maintenance.

Introduction to Maintaining Your Equipment

This manual contains sufficient information for proper maintenance under most conditions. Certain operating environments may necessitate preventive maintenance at more frequent intervals. Because consistent preventive maintenance is vital for keeping mechanical equipment in good operating condition, MiTek recommends that you stock certain replacement parts to minimize downtime.

Review the table of contents and utilize the index to locate the information you need. The following appendices will also assist in maintaining and repairing your equipment:

- Troubleshooting
- Parts List
- Maintenance Checklists
- Drawing Set

Refer to page 68 for an overview of component locations that may require maintenance during the life of your equipment.



Read the *Performing Maintenance Safely* section before beginning maintenance on this equipment.



Performing Maintenance Safely



Read the safety section starting on page x and adhere to all rules and guidelines. This section provides additional safety information specific to maintenance topics.

Before Operating This Equipment

Adhere to these warnings before operating this equipment:

	<p style="text-align: center;"> WARNING</p> <p>ELECTROCUTION, HIGH PRESSURE, CRUSH AND HAZARDS!</p> <p>Read this section AND the safety section in the preliminary pages before operating or maintaining this equipment.</p> <p>Do not operate this machine until you have a thorough understanding of all controls, safety devices, E-stops, and operating procedures outlined in this manual.</p> <p>Read and observe all hazard instructions. Failure to do so may result in economic loss, property damage, and/or personal injury.</p> <p>This manual must always be available to personnel operating and maintaining this equipment.</p>
---	--





	<p style="text-align: center;"> WARNING</p> <p>CRUSH AND CUT HAZARD</p> <p>Guards must always be in place during operation to avoid serious injury and possibly death.</p> <p>Always replace guards after maintenance is complete and before removing the lockout/tagout device.</p>
---	---

	<p style="text-align: center;"> WARNING</p> <p>CRUSH AND CUT HAZARD.</p> <p>Before turning on the equipment, make sure that all personnel and equipment are clear.</p>
---	---



Lockout/Tagout

The lock and tag symbol shown to the left indicates that proper lockout/tagout procedures must be used prior to starting the procedure where the symbol occurs.

 WARNING	
	<p>ELECTROCUTION AND HIGH PRESSURE HAZARDS.</p> <p>Always turn the power off by activating an E-stop when the equipment is not in operation.</p>
	<p>Always verify that all power to the machine has been turned off and follow approved lockout/tagout safety procedures (OSHA 29 CFR 1910.147) before performing any maintenance on this equipment.</p>
	<p>If it is absolutely necessary to troubleshoot an energized machine, follow NFPA 70E or the governing regulations at your location for proper procedures and personal protective equipment.</p>
	<p>The components on this machine can cause severe injury if adjusted improperly. Follow all procedures in this manual and do not make adjustments to the machine without guidance from MiTek or MiTek documentation.</p> <p>Only trained personnel should make mechanical adjustments to this machine.</p>



Important Safety Information

Your Responsibilities

Detailed descriptions of standard workshop procedures, safety principles, and service operations are not included in this manual. Although this manual contains some warnings and cautions against specific service methods which could cause personal injury or damage to the machine, it does not cover all conceivable service procedures which might be done or the possibility of hazardous consequences of every conceivable method. If you intend to handle, operate, or service the unit by a procedure or method not specifically recommended by the manufacturer, first make sure that such a procedure or method will not render this equipment unsafe or pose a threat to you and others.

It is the responsibility of the mechanic performing the maintenance or service on a particular machine to:

1. Inspect the machine for abnormal wear and damage.
2. Choose a procedure which will not endanger his/her safety, the safety of others, the equipment, or the safe operation of the machine.
3. Fully inspect and test the machine and the hydraulic, pneumatic and electrical systems to ensure that the service to the machine has been properly performed and that the machine, hydraulic, pneumatic and electric systems will function properly.
4. Ensure only qualified electricians perform electrical service work.

	 WARNING
	This machine contains high-voltage electricity which may cause serious personal injury or death.



General Service Rules

1. The design may change or upgrades may occur for any particular component. Always contact the factory before replacing components.
2. If inspection or testing reveals evidence of abnormal wear or damage to the machine or if you encounter circumstances not covered in the Equipment Manual, consult MiTek. The machine must be repaired and serviced according to the current specifications and procedures of MiTek using replacement parts with properties equal to or greater than those specified by MiTek.
3. Use the correct tools and procedures on this machine to avoid damage and incorrect assembly.
4. If worn or damaged, replace gaskets, O-rings, cotter pins, etc., and place *Loctite* on bolts, if appropriate.
5. Torque bolts and fasteners to the correct specifications.
6. Clean parts in a nonflammable or high-flash-point solvent only.
7. Lubricate any sliding surfaces before assembly.
8. Many components are manufactured from high carbon, heat-treated steel. Do not attempt to cold straighten, hot straighten, bend, or weld these components, as they may fail under load causing serious personal injury or death.

9. After re-assembly, check all parts for proper installation and operation before putting the machine back into service.
10. It is beneficial to record all major maintenance and testing. This allows recurring problems to be predicted and addressed before any production time is lost. Typical reports and records should include:
 - Date
 - Serial number of machine
 - Description of problem or symptoms
 - Corrective action taken
 - Parts required
11. MiTek will, from time to time, mail out service bulletins and updates for this machine. Follow the Service Bulletins and updates accordingly and file them in this equipment manual.

Making Adjustments and Replacing Parts









Be careful when making mechanical adjustments. Untrained personnel may damage the machine or cause harm to themselves and others.

	 WARNING
	<p>CRUSH AND CUT HAZARDS.</p> <p>Always replace guards after servicing.</p> <p>Only qualified maintenance personnel shall repair, remove, or replace guards and safety devices.</p>

	NOTICE
	<p>Failure to follow the step-by-step procedure may result in incorrect adjustment of this machine and could cause incorrect setups. Only trained personnel should make mechanical adjustments to this machine.</p> <p>Use the exact replacement parts that are specified.</p>

Special materials have been used for some of the components of this equipment. It is critical to the future performance of this machine that only specified replacement parts are used. Order all replacement parts through MiTek. Do not substitute parts without first consulting MiTek to determine if it is safe and effective. No electrical system component, cable, connector, or device should be modified, removed, disconnected, changed without specific approval and guidance from MiTek.

Wearing Personal Protective Equipment

 CAUTION	
      	<p>Follow OSHA guidelines to utilize the proper personal protective equipment (PPE) while performing maintenance. The most common include eye protection, hearing protection, dust masks while blowing off sawdust, gloves while working with solvents, and fire retardant clothing when troubleshooting an energized machine.</p>

Conducting Safety Tests

Ensure safety devices are always operating properly. Perform the safety tests described on page xxi before operating the equipment at the initial startup, after performing any maintenance, and in accordance with the maintenance schedule.

Overview Graphics

Figure 7-1 and Figure 7-2 provide an important overview of the equipment to help you better understand the procedures in the *Maintenance* chapter.

Figure 7-1: Components Located on the Ends of the Gantry Head

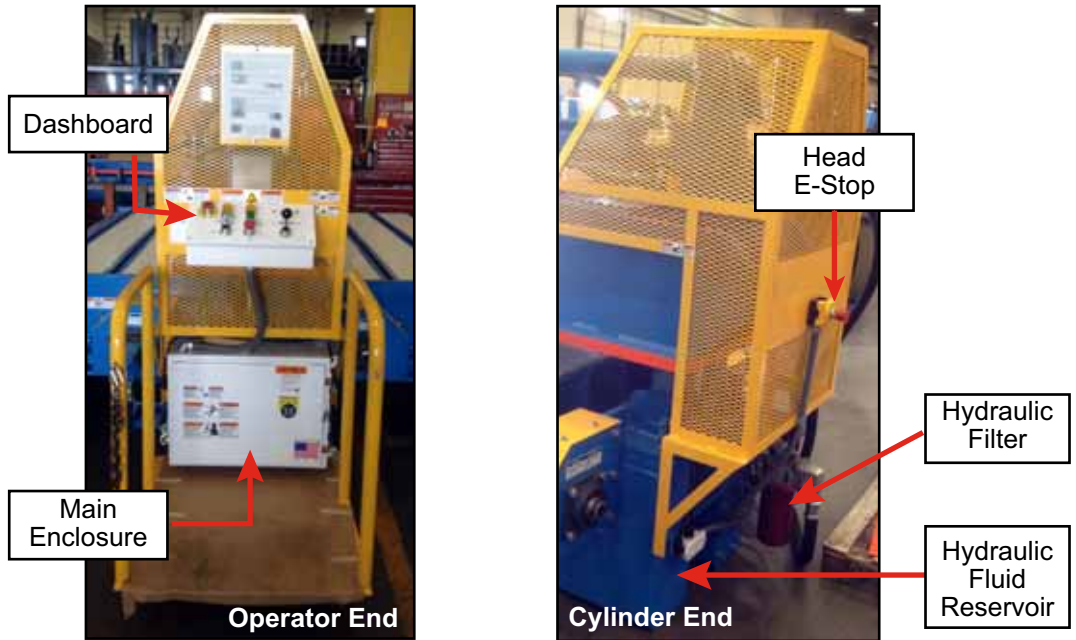
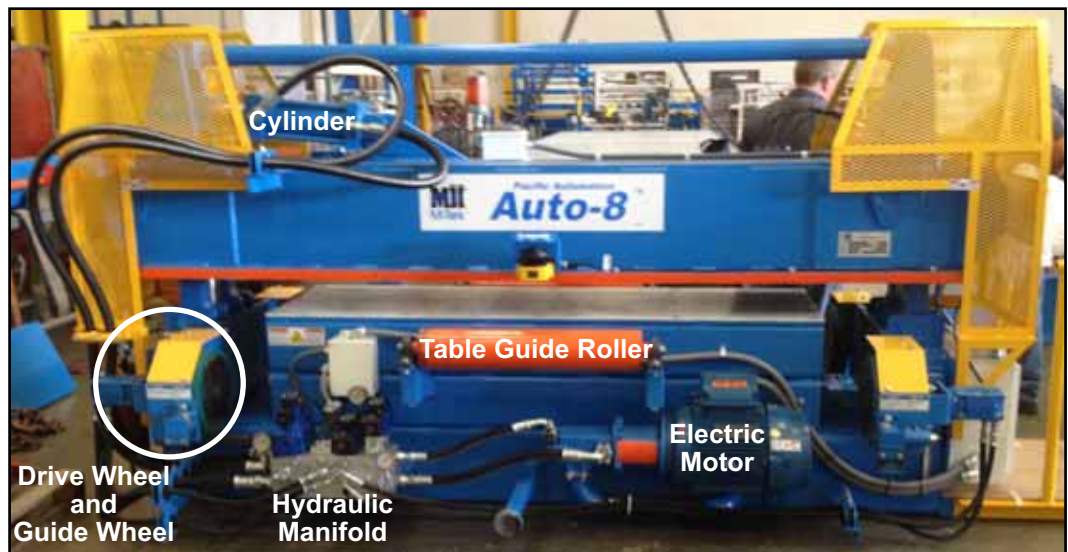

Figure 7-2: Components Located on the Sides of the Gantry Head



Hydraulic Fluid Maintenance

Hydraulic Fluid Specifications and Information

The hydraulic fluid used in this system is a high quality, straight-weight oil. Hydraulic fluids come in several grades. Refer to Table 7-2 for the specific grade and operating temperature ranges.

Table 7-1: Hydraulic Fluid Needed for Startup (also in *Prior to Installation* chapter)

Auto 8 press	45 gallons
Auto 10 press	60 gallons



Table 7-2: Hydraulic Fluid Specifications (also in *Prior to Installation* chapter)

Recommended Operating Viscosity Range	60-245 SUS	
Temperature	At Startup	< 68°F (20°C)
	During Operation	86° to 120°F (30° to 49°C)
ISO Grade ^a	32	

- a. If operating outside of the recommended temperature range, select a hydraulic fluid that will operate at the proper SUS range for your temperatures.

NOTICE	
	<p>Starting the machine with the hydraulic fluid at a temperature <u>below</u> the minimum startup temperature allowed will cause severe damage to the hydraulic system. If needed, an in-tank submersible heater should be used in the reservoir.</p> <p>Operating the machine with the hydraulic fluid temperature <u>above</u> maximum operating temperature allowed will cause severe damage to the hydraulic system.</p>

Hydraulic Fluid Inspection

 WARNING	
	<p>Maintenance should be performed only by trained personnel.</p> <p>Never operate the machine if any hydraulic hoses are cracked or broken. Serious personal injury could result.</p>
	<p>The hydraulic fluid in the tank and the various components can cause serious burns. Do not perform any service work without first allowing the oil and corresponding components to cool down to less than 100°F (38°C).</p>

Perform the following inspection at least once a week. Note that the temperature should be checked daily, before starting the pump each day.

1. Before starting the pump each day:
 - Inspect the hydraulic fluid level (see page 71).
 - Inspect the hydraulic fluid temperature (see page 69).
2. Inspect for hydraulic fluid leaks.

Hydraulic fluid leaks are most often due to loosened hydraulic fittings, damaged seals in components, or damaged hoses. If oil appears in excess anywhere on the press, find the source and have a qualified hydraulics technician correct it immediately. Clean up any oil on the press or floor as it is a safety hazard.

If the machine runs at temperatures greater than 160°F (71°C), the hydraulic seals and hoses will harden and rapidly deteriorate, causing frequent leaks.

PN



Upon using an E-stop pushbutton or scanner, the seals below the hydraulic valve may have extruded from their seat. Inspect the system carefully and order the seal kit listed in the Parts List if needed.

3. Inspect the hydraulic hoses.

Any hose which exhibits a lack of flexibility, cracks in the outer casing, punctures or worn areas must be replaced.

Filling the Hydraulic Fluid Level



Hydraulic fluid
Lock and tag
Funnel
Clean rags

The hydraulic fluid level can be read on the oil level/temperature gauge mounted on the frame of the machine. When the oil is hot, oil level should be at the Full level. If level is low, replenish with a high quality, anti-wear hydraulic fluid of the correct weight. (Refer to page 69.)

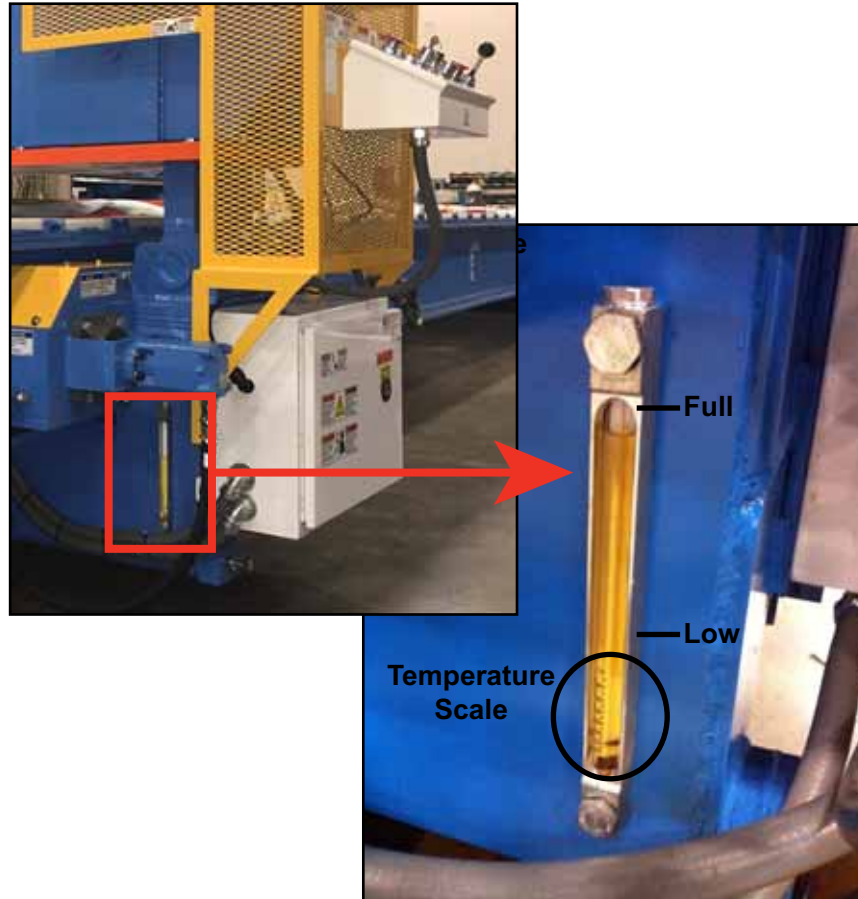

Figure 7-3: Hydraulic Fluid Level and Temperature Gauge





Refer to Figure 7-3, Figure 7-4, and these steps to fill the hydraulic fluid.

1. Clean off the filler/breather and surrounding area.
2. Remove the filler/breather cap.
3. Insert the funnel.

 CAUTION	
	<p>SLIP HAZARD.</p> <p>Do not overfill. Clean up any spillage immediately to avoid injury.</p>

4. Add hydraulic fluid until the oil level is shows full on the temperature gauge.
5. Remove the funnel and replace the filler/breather cap.

Figure 7-4: Hydraulic Fluid Filler/Breather Cap

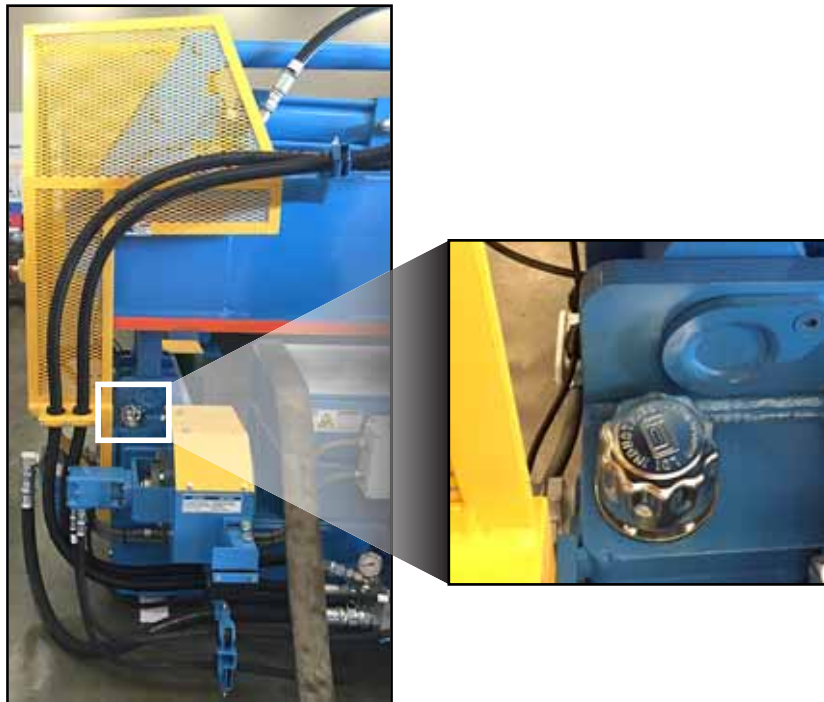

NOTICE	
	<p>Never re-use hydraulic fluid. Discard of fluid according to local and nation regulations.</p>

Reading the Oil Filter Bypass Gauge

With the machine idling and the oil at operating temperature, check the oil filter bypass gauge mounted on the oil filter housing. When the pressure at the incoming side and the outgoing side of the filter are the same, the filter element is clean and the bypass gauge shows green. When the filter becomes dirty, the pressure differential causes the gauge to turn red to remind you to replace the filter element. It should be changed at least once a year.

See page 74 for the procedure to replace the filter element.

NOTICE	
	<p>The oil filter bypass gauge is red only when pressure is high (during operation). It will return to green when pressure is low (the machine is off). If it is red during pressing or traveling, change the filter element!</p>

Figure 7-5: Hydraulic Fluid Filter Location and Bypass Gauge



Replacing the Hydraulic Fluid Filter Element

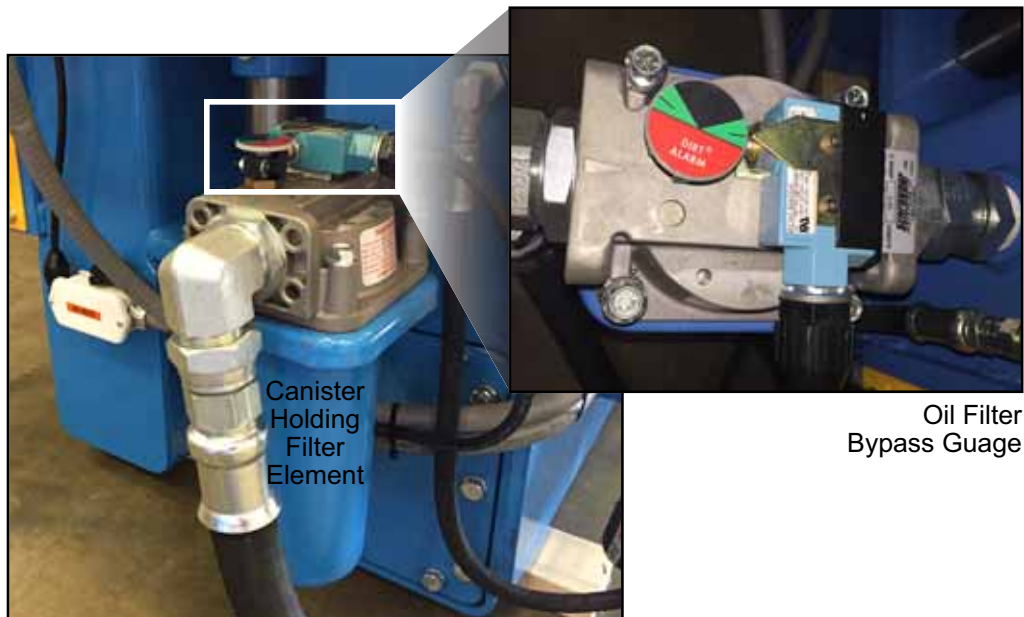

After completely replacing hydraulic fluid, the filter element should be changed before refilling the reservoir AND 3-6 months after the hydraulic fluid is changed. New hydraulic fluid is not always filtered and may wear out the return line filters quickly.

The hydraulic fluid filter is designed to filter out harmful particles from the hydraulic system. On the filter, there is an indicator gauge showing the amount of oil bypassing the internal filter element. If the indicator shows a red stripe during operation, it is time to replace the filter element. Refer to the graphic on page 73 and replace the filter element by following these steps:



1. Lockout/tagout.
2. Remove the 4 bolts holding the filter bowl to the porting head.
 - a) Use a 9/16" socket to turn the bolts counterclockwise, loosening two opposite corners first, then the next two opposite corners.
 - b) The bowl has a spring inside which will slightly push the canister out once the last bolt is loosened, so hold a hand under the canister to catch it.
3. Discard the old element and the fluid from the filter bowl.
4. Clean and prepare the canister for reassembly:
 - a) Use a cloth with a non-flammable cleaner (brake cleaner) to clean out the canister, removing any particles along the inside wall.
 - b) Check the O-ring that is located between the canister and the porting head for any damage. Replace if necessary.
 - c) Lubricate the O-rings on the element and on the filter bowl.
5. Place the element into the filter bowl with the spring facing down.
6. Guide the canister back onto the head, while guiding the element into a pressed fit inside the head. Note: The spring is under compression during this step.
7. Place the filter bowl back onto the porting head and tighten the bolts in this pattern: bottom right, top left, top right, bottom left. Do not over-tighten, but ensure consistent tension around the circumference.

PN

	ENVIRONMENTAL
	Always dispose of rags or any other object soiled with hydraulic fluid in accordance with local, state, and federal laws.



Replacing the Hydraulic Fluid

The acceptable time between hydraulic fluid changes depends on both the fluid used and the operating conditions involved.

- Hydraulic fluid
- Barrel to Hold Used fluid
- Non-Flammable Solvent or Varsol
- Lock and tag
- 2 Hydraulic Bottle Jacks
- Air-Powered Oil Pump
- Socket Set
- Screwdriver Set
- Drain Pan
- Clean Rags



In general, fluid should be changed when contaminated with water or dirt. Periodic laboratory analysis is the most accurate method to determine when and how often fluid should be changed. The supplier can often run these tests, or check the condition of the used oil. A trained maintenance mechanic can quickly determine the fluid level in the reservoir sight gauge and possible water contamination. Dirt and discolored oil both indicate that the oil should be changed. Additional indicators that the fluid must be changed are unusual noises, excessive temperatures, excessive vibration, leaking lines and fittings, and oil deposits on or around the machine.

Completely drain and refill the reservoir if you change the type of hydraulic fluid in use.

At a minimum, it is recommended to completely drain and replace the hydraulic fluid every year. Always use a hydraulic fluid that matches the specifications described on page 69.

Tips for Replacing Hydraulic Fluid

- It is best to change hydraulic fluid when the system is at operating temperature. This will drain off as much of the impurities in suspension as possible.
- To eliminate the possibility of spillage, use a suction pump to remove the fluid from the reservoir. Some suppliers offer this service.
- Always replace the return line filter when changing the fluid, and again shortly thereafter.
- Completely drain and refill the reservoir if you change the type of hydraulic fluid in use.

	<p>Mixing synthetic lubricants with mineral lubricants is not recommended. Check with your lubricant supplier.</p>
---	---

Hydraulic Fluid Requirements

To refill the reservoir, have the correct amount of clean hydraulic fluid available before starting this procedure. Refer to the reservoir capacity listed on page 7.

Procedure for Replacing Hydraulic Fluid



Refer to page 69 for hydraulic fluid specs.

The press requires a complete hydraulic fluid and filter change annually, or every 2,000 hours of operation. Hydraulic fluid does not get dirty like automotive oil, but heat causes the hydraulic fluid to break down and the additives wear out. Although the oil may still look clean, it will not provide adequate lubrication of the hydraulic components. Changing the oil annually will prolong the life of the hydraulic system.





New hydraulic fluid is not always filtered and may wear out the return line filters quickly. Ensure that you have a filter to be used as a replacement part shortly after replacing hydraulic fluid.

The procedure to change hydraulic fluid follows:

1. Travel the press head to the left end of the table.
2. Move the joystick to the Down position to lower the pressing platen. Press the STOP button just as the platen reaches its lowest position. Do not build up any hydraulic pressure in the Down mode.
3. Check the oil temperature on the sight gauge. Allow the oil to cool down to room temperature.
4. Lockout /tagout the main power to the machine.
5. Clean off the area around the oil filter assembly, inspection cover, and filler/breather.



 WARNING	
	<p>HIGH PRESSURE AND BURN HAZARD.</p> <p>Be careful to keep a strong grip on the hose and always point it away from people to prevent high-pressure injuries.</p>
	<p>The hydraulic fluid in the tank and the various components can cause serious burns. Do not perform any service work without first allowing the oil and corresponding components to cool down to less than 100°F (38°C).</p>



Ensure the disposal container can hold the full volume of hydraulic fluid.

Reservoir Capacity

Auto 8: 45 gal

Auto 10: 60 gal

PN

6. Remove the hydraulic fluid from the reservoir using one of these methods:

- Drain the hydraulic fluid into a large pan, taking care to protect the floor from fluid spillage.

OR

- Pump the hydraulic fluid out through the fill cap shown on page 72. Be sure to remove the breather screen first.

7. Replace the oil filter element as instructed on page 74.

8. Refill with approved hydraulic fluid listed on page 17.



Hydraulic fluid will expand when warm. Do not fill completely to the top.

9. Dispose of used oil and rags in a safe, approved manner.

10. Replace the filter element again 3-6 months after the oil change occurs.

Figure 7-6: Draining the Reservoir



Hydraulic System Maintenance & Repair

Overview of Hydraulic Manifold and Valves

Refer to page 79 for a description of each of the components labeled here.

Figure 7-7: Front and Top of Hydraulic Manifold

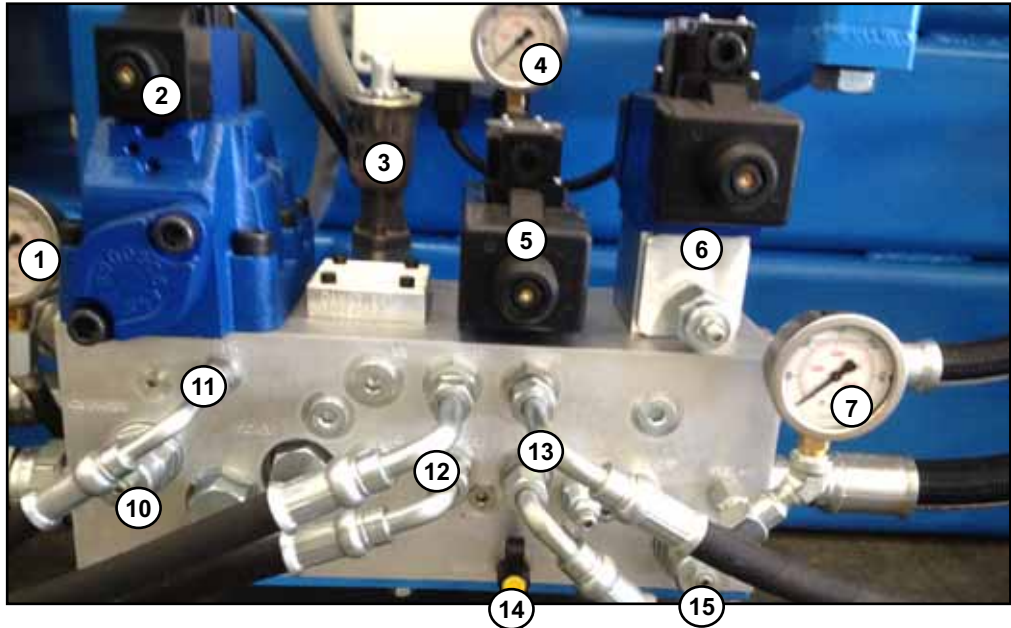
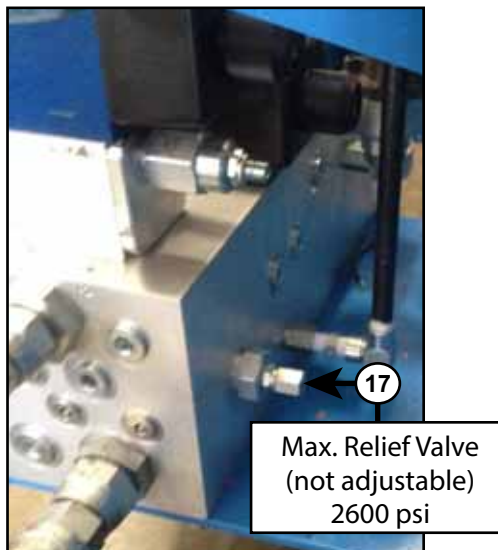

Figure 7-8: Back Side of Manifold





See **Figure 7-7**
through
Figure 7-8

Table 7-3: Description of Components on Front of Manifold (See Figure 7-7)

	Name & (Recommended Setting)	Description
1	Counterbalance Gauge	Gauge showing current pressure on counterbalance valves that keeps back pressure on cylinder.
2	Press Valve	Directional valve that controls the up and down motion of the platen. No adjustment; controlled by System Pressure Relief Valve (see page 82).
3	Pressure Switch	Limits overall pressure of pressing cycle; platen raises when pressure reaches setting on this switch. Should be set at approx. 1600 psi (1200-2500 psi).
4	Hi Flow Pump Gauge	Shows the use of the Hi Flow Pump. It should remain below approximately 500 psi.
5	Safety Valve	Redundant, directional valve that assists in quick stopping when an E-stop or scanner is used.
6	Drive Cushion Valves (1500 psi)	Cross port relief valves that controls the stop time of hydraulic drive motors. Recirculates hydraulic fluid on a normal stop to reduce pressure on valves and seals.
7	System Pressure Gauge	Shows real-time pressure of overall hydraulic system.
	Motor Directional Valve	Drives the hydraulic motors for horizontal travel.
10	Press Counterbalance Valve (1000 psi)	Unloading valve for press platen. It applies back pressure on the cylinder to hold th platen up. Set at 1000 psi.
11	Drain	Drains fluid that shifts Press Valve and sends it back to the reservoir.
12	Outgoing lines to drive motor on that side	1 drives motor forward, 1 drives motor backward.
13	Outgoing lines to drive motor on that side	1 drives motor forward, 1 drives motor backward.
14	Prime	Port to attach hose to for priming motor.
15	Adjustable Relief Valve (1600 psi)	Controls the system pressure. Can be adjusted between 1200-1800 psi.
	Unloading Valve (1000 psi)	Works with unloading circuit for tandem pump system.
17	Max. Relief Valve (2500 psi)	Non-adjustable relief valve that indicates the maximum pressure the press is capable of handling. It is utilized in Boost Mode.

Understanding the Table Valves

The relief valves (or pressure relief valves) control the amount of pressure reaching the other valves in the line, which are the cross port relief valves and flow control valves.

A cross port relief valve is also known as a cushion valve, cross over relief valve, or brake valve. The cross port relief valves prevent the hydraulic motor from over-pressurization due to a rapid stop. If set too low, the motor will never rotate. If set too high, motor stops may become too sudden.

There are two (2) sides to a cross port relief valve. One side controls the table going in and the other controls the table coming out. It is best to set one side at a time.

The flow control valves work with the cross port relief valves to fine-tune the setting.

The solenoids provide electrical signals to the pilot valves and are located on top of each valve stack.

Adjusting the Pressure Setting

 WARNING	
	<p>Only qualified personnel familiar with hydraulic and electric components and their hazards should perform this adjustment.</p>
	<p>Always lockout/tagout the main power to the machine before making any mechanical, hydraulic or electrical adjustments or performing maintenance.</p>
	<p>High-voltage electrical conductor rails located underneath the table can cause serious injury or death if contacted.</p> <p>Do not adjust or set hydraulic pressures if any hose fittings or components show signs of wear or leakage. Have a qualified hydraulics person repair the problem.</p>
	<p>Wear safety glasses and appropriate personal protective equipment.</p> <p>The hydraulic fluid can cause serious burns. Do not perform any service work without first allowing the oil and corresponding components to cool down to less than 100°F (38°C).</p>



Screwdriver set

Socket set

2x4 blocking

Lock and tag



Do not set the Normal pressure switch below 1200 psi or above 1800 psi.



Adjusting the Working Pressure (Pressure Switch)

The working pressure is the pressure at which the platen releases the truss (raises up) during a normal (unboosted), automatic pressing cycle. This pressure switch is factory set at 1600 psi, but can be easily adjusted to suit your pressing requirement. The adjustable range is from 1200 psi to 2500 psi, but in order to prolong the life of the hydraulic system components, it is highly recommended to avoid the higher settings.

For the most efficient use of your press, leave the working pressure where it will press 90% of your plates. The remaining plates can be pressed using the Boost feature. In rare cases, you may want to set the normal pressing tonnage higher than the factory set point of 1600 psi or 31 tons. This can be accomplished by adjusting the pressure switch to a higher setting as described in this section.

1. Turn off and lockout the main power to the machine.
2. Remove the protective cap on the top of the pressure switch if it is present. The pressure switch is shown on page 78.
3. Using a screwdriver, turn the adjusting screw Out (counterclockwise) to increase the pressure, or In (clockwise) to reduce the pressure.
4. Replace the protective cap.

Adjusting the Adjustable Relief Valve

To adjust the System Pressure Relief Valve, remove the cap, loosen the jam nut, and adjust the internal hex screw clockwise to increase the pressure setting or counterclockwise to decrease the pressure setting.

Adjusting Drive Cushion Valve

Only adjust the drive cushion valve as a last resort.

The press incorporates the use of a cushion valve in the hydraulic system. This valve controls the acceleration and deceleration of the press when it travels. It does not affect the speed of travel, only the response of stopping and starting. The smoother the system responds, the longer the life of the drive components. If the cushion valve pressure is set too high, the drive wheels will spin upon starting and skid upon stopping. If the cushion valve pressure is set too low, the press will accelerate too slowly and coast too far.







- Hex key
- Socket set
- Safety glasses
- Combination wrench set
- Lock and tag



	NOTICE
	<p>Exceeding a drive pressure of 1600 psi may cause premature motor, wheel, or drive spline failure.</p>

Replacing a Hydraulic Valve

If it is necessary to replace a hydraulic valve, follow these guidelines and safety notes:

 WARNING	
	<p>Only qualified personnel familiar with hydraulic and electric components and their hazards should perform this work.</p> <p>Always lockout/tagout the main power to the machine before making any mechanical, hydraulic or electrical adjustments or performing maintenance.</p> <p>High-voltage electrical conductor rails located underneath the table can cause serious injury or death if contacted.</p>

 WARNING	
	<p>Do not install any hydraulic valve on this machine other than the specific models installed by MiTek.</p> <p>The original valves used have special pressure and flow ratings. Although other valves may bolt on, they will not have the proper ratings and may fail causing serious personal injury or death.</p>

 WARNING	
 	<p>Do not remove any hose or valve without first:</p> <ol style="list-style-type: none"> 1) Lowering the platen so that it physically stops and is not being held up by hydraulic pressure; 2) Ensuring that no hydraulic pressure has built up in the system. 3) Wear eye protection and appropriate PPE. <p>Even with the machine turned off, the residual hydraulic pressure may cause serious injury.</p>

To replace a valve:

1. Check the oil temperature on the oil level/temperature gauge. Allow the oil to cool down to less than 100°F (38°C).
2. Place 2x4 blocking on each side of the table, at the left end of the table.
3. Travel the press head over the blocking.
4. Move the joystick to the Down position to lower the pressing platen. press the STOP button just as the platen reaches its lowest position and the platen is resting on the 2x4 blocking. Do not build up any hydraulic pressure in the Down mode.
5. Turn off and lockout the main power to the machine.



- Correct valve
- O-ring kit, if needed
- Screwdriver set
- Socket set
- 2x4 blocking
- Hex key socket set
- Torque wrench
- Clean rags
- Oil pump
- Wrench set
- Empty barrel
- Drain pan
- Safety glasses
- Lock and tag
- Hearing protection





The remaining procedure depends on which valve is being replaced, but the guidelines below apply to all of them:

- Blow off and wipe off dirt and grease from the immediate area. When removing a hydraulic valve, it is extremely important not to let dirt enter the hydraulic system.
- Catch potential hydraulic fluid in a pan to avoid messy slip hazards.
- Always write down wire numbers and locations before disconnecting any wiring.
- Always use O-rings purchased from the original manufacturer or MiTek.
- Check the hydraulic fluid and add new fluid if needed. Never pour used hydraulic fluid back into the system or reservoir. Dirt particles are the primary cause of valve malfunction.



Removing a valve from the hydraulic manifold will allow a slow flow of oil to siphon out of the tank. If the valve is going to be replaced with a new valve immediately, there is no need to drain the oil tank. If the valve is going to be off for more than 5 to 10 minutes, it is best to drain the oil tank. (Refer to procedure starting on page 75.)

Replacing Hydraulic Hoses

 WARNING	
	<p>Only qualified personnel familiar with hydraulic and electric components and their hazards should perform this adjustment.</p>
	<p>High-voltage electrical conductor rails located underneath the table can cause serious injury or death if contacted.</p>
	<p>Do not adjust or set hydraulic pressures if any hose fittings or components show signs of wear or leakage. First, have a qualified hydraulics person repair the problem.</p>
	<p>Wear safety glasses and appropriate personal protective equipment.</p> <p>The hydraulic fluid can cause serious burns. Do not perform any service work without first allowing the oil and corresponding components to cool down to less than 100°F (38°C).</p>



- Combination wrench set
- Adjustable wrench
- Pipe wrench
- Clean rags
- Hoses
- Screwdriver
- Pump
- Safety glasses
- Drain pan
- Lock and tag

Sudden surges of hydraulic pressure cause hoses to flex during operation of the press. This action can wear or puncture a hose if it is rubbed against a sharp edge. If a hose has been damaged, replace it immediately. Hoses routed around sharp edges should be clamped in hose supports to prevent wear.

Heat causes hoses to deteriorate. Any hose which exhibits a lack of flexibility, or cracks in the outer casing, must be replaced.



All hydraulic hoses originate from the hydraulic power pack system located on the left-hand side of the press head. If possible, travel the head to the left end of the table for ease of access. Leaks or damage of a serious nature will require immediate repair before moving or starting the machine.

If the main suction hose requires replacing, the hydraulic tank must be drained. (Refer to the Oil Change Procedure, page 125.) All other hoses can be removed without draining the tank.





This machine uses both pipe thread (NPT) and straight thread O-ring (ORB) fittings. These fittings are not interchangeable.

1. Create a safe environment:
 - a) Check the oil temperature on the oil level/temperature gauge. Allow the oil to cool down to less than 100°F (38°C).
 - b) Place 2x4 blocking on each side of the table.
2. Move the platens to their extended position by performing these steps:
 - a) Start the machine.
 - b) Travel the press head over the blocking.
 - c) Move the joystick to the Down position to lower the pressing platen. Press the Stop button just as the platen reaches its lowest position and the hydraulic cylinder rod is fully extended. Do not build up any hydraulic pressure in the Down mode.

 WARNING	
	<p>Do not remove any hose or valve without first:</p> <ol style="list-style-type: none"> 1) Lowering the platen so that it physically stops and is not being held up by hydraulic pressure; 2) Ensuring that no hydraulic pressure has built up in the system. 3) Wear eye protection and appropriate PPE. <p>Even with the machine turned off, the residual hydraulic pressure may cause serious injury.</p>





3. Turn off and lockout the main power to the machine.
4. Remove the left-hand table end cover.

 WARNING	
	<p>High-voltage electrical conductor rails located underneath the table can cause serious injury or death if contacted.</p>

5. Remove the hose:

- a) Use compressed air to blow off any sawdust or dirt which may have accumulated on the hose connections.
- b) Remove hose clamps or supports, if applicable.
- c) Place a drain pan under the hose fittings to contain the oil.
- d) Wrap rags around each of the two pressing cylinder hose fittings where they enter the cylinder.

	 WARNING
	<p>Do not remove any hose or valve without first:</p> <ul style="list-style-type: none"> 1) Lowering the platen so that it physically stops and is not being held up by hydraulic pressure; 2) Ensuring that no hydraulic pressure has built up in the system. 3) Wear eye protection and appropriate PPE. <p>Even with the machine turned off, the residual hydraulic pressure may cause serious injury.</p>



- e) Carefully crack loose each hose fitting to remove any residual hydraulic pressure. Eye protection and protective clothing must be worn.
- f) Remove the damaged hose.

6. Install a new hose of the correct size, pressure rating, and hose fitting type.

7. Replace hose clamps and supports.

8. Start the machine and test.

9. Replace the table end cover.

	 WARNING
	<p>Never operator this equipment without all guards and safety devices in place.</p> <p>High-voltage electrical conductor rails located underneath the table can cause serious injury or death if contacted.</p>

Priming the Pump

Figure 7-9: Priming the Pump

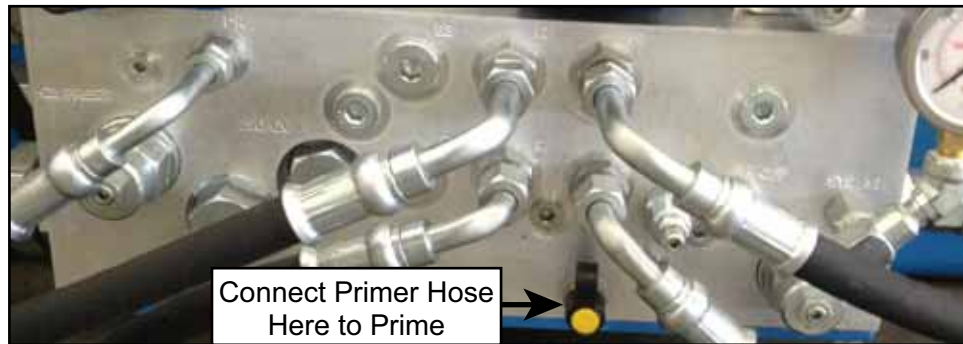

The hydraulic system pump must be primed when first starting up and after draining the reservoir for any reason.

1. Locate the primer hose that was supplied for this purpose. It may be looped around the drain valve on the end of the pump.
2. Screw either end of the hose onto the primer hose port shown in Figure 7-9.
3. Hold the opposite end of the primer hose in a small bucket to catch hydraulic fluid.
4. Press the START button.
5. Hold the primer hose in the bucket until all air is pushed out of the system.

When the air is released, the following will occur:

- A small amount of hydraulic fluid will begin to leak out of the hose.
 - The noise generated by the pump will change to a louder decibel which should be the sound during normal operation.
6. Once the air is released, unscrew the primer hose from the drain valve. The valve seals itself, so no oil should leak out from the drain valve.
 7. Drain any residual oil out of the primer hose and place the primer hose in a safe place for future use. It will be needed the next time the hydraulic fluid is drained for preventive maintenance purposes.



There are 2 pumps in use inside the same pump housing. They are both primed at the same time when using the procedure described here.

Hydraulic Cylinder Replacement & Repair





Removing the Hydraulic Pressing Cylinder and Rod Eye

If the hydraulic cylinder leaks or the rod is damaged, use the following procedure to remove them:





Wrench set
 Brass drift
 Clean rags
 Oxy/acetylene torch
 Hex key socket set
 2 lb hammer
 Wooden blocks
 Pry bar
 Drain pan
 Fire extinguisher
 Loctite #262
 Safety glasses
 Lock and tag

1. Create a safe environment:
 - a) Check the oil temperature on the oil level/temperature gauge. Allow the oil to cool down to less than 100°F (38°C).
 - b) Place 2x4 blocking on each side of the table.
2. Move the platens to their extended position by performing these steps:
 - a) Start the machine.
 - b) Travel the press head over the blocking.
 - c) Move the joystick to the Down position to lower the pressing platen. Press the Stop button just as the platen reaches its lowest position and the hydraulic cylinder rod is fully extended. Do not build up any hydraulic pressure in the Down mode.

 WARNING	
  	<p>Do not remove any hose or valve without first:</p> <ol style="list-style-type: none"> 1) Lowering the platen so that it physically stops and is not being held up by hydraulic pressure; 2) Ensuring that no hydraulic pressure has built up in the system. 3) Wear eye protection and appropriate PPE. <p>Even with the machine turned off, the residual hydraulic pressure may cause serious injury.</p>



3. Turn off and lockout the main power to the machine.
4. Remove guards.
5. Clean and support the cylinder:
 - a) Clean all sawdust, dirt and oil residue from the cylinder, hoses and area.
 - b) Place wooden blocks under the cylinder to support its weight.

 WARNING	
 	<p>FIRE AND EXPLOSION HAZARD!</p> <p>Use extreme caution when using oxy/acetylene torch in the truss plant due to fire and/or explosion hazards. Wear appropriate PPE including eye protection.</p>

6. Remove the rod eye pin retaining bolt and clevis pin retaining bolt:

Figure 7-10: Cylinder on Gantry Head

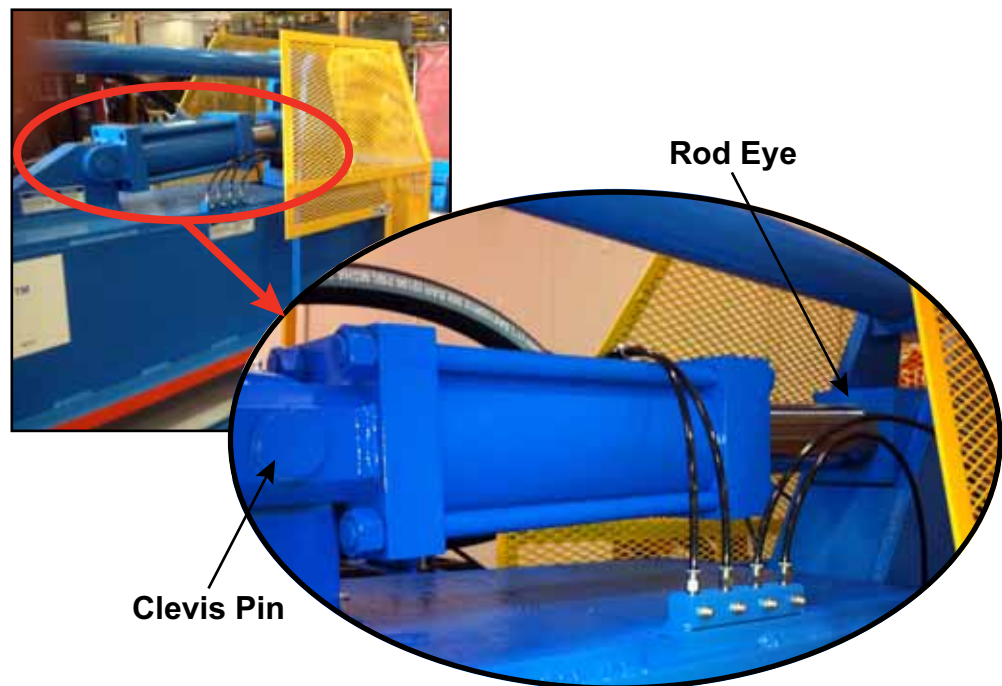





- a) The retaining bolts on the cylinder rod eye pin and the clevis pin are permanently held in place with a thread adhesive and must be heated to break the bond. Use an oxy/acetylene torch to heat up the heads of the retaining bolts until they can be loosened.
- b) Remove rod eye pin retaining bolt.
- c) Remove clevis pin retaining bolt.



7. Remove the hoses:



- a) Mark both cylinder hoses for future reference.
- b) Wrap rags around each of the two pressing cylinder hose fittings where they enter the cylinder.

	 WARNING
  	<p>Do not remove any hose or valve without first:</p> <ul style="list-style-type: none"> 1) Lowering the platen so that it physically stops and is not being held up by hydraulic pressure; 2) Ensuring that no hydraulic pressure has built up in the system. 3) Wear eye protection and appropriate PPE. <p>Even with the machine turned off, the residual hydraulic pressure may cause serious injury.</p>

- c) Carefully crack loose each hose fitting to remove any residual hydraulic pressure. Eye protection and protective clothing must be worn.
 - d) Remove both cylinder hoses and place in a bucket.
8. Using a brass drift and hammer, remove the clevis pin and rod eye pin.
9. Carefully lift off the hydraulic cylinder and rod eye.

	 CAUTION
	<p>Use a crane or other lifting assistance.</p> <p>Cylinder and rod eye weigh 190 lbs.</p>

10. Replace the cylinder in the opposite order of the steps just completed.
- Use *Loctite* #262 on pin retaining bolts.
11. Replace all guards.

Removing the Cylinder Rod Eye from the Cylinder

The rod eye must be removed to allow the hydraulic cylinder to be rebuilt. The procedure for removal is as follows:



1. Clamp the cylinder in a vise.
2. Remove rod eye set screw and plastic plug.



Using an adjustable wrench on wrench flat on end of rod. Do not use a pipe wrench on the cylinder rod as any burrs on the rod will immediately ruin the gland seals.



Large vise
Adjustable wrench
Non-flammable solvent
Plastic set screw plug
Pry bar
Thread chaser
Brass brush
Anti-seize compound
Hex key set
Three-square file
Clean rags
Lock and tag

3. Using a bar in the rod eye pin hole, unscrew the rod eye.
4. To reinstall the rod eye, use the reverse procedure.
5. Make sure the threads on the cylinder rod and rod eye are absolutely clean. Any small nicks or burrs on the threads must be removed prior to installation. Use a three-square file or thread chaser to clean up the threads.
6. Coat the rod threads with anti-seize compound.
7. Thread the rod eye onto the cylinder rod.
 - If the rod eye does not thread on easily by hand, stop, remove it, inspect, and re-clean the threads.
 - Do not force the rod eye onto the rod as it will seize on part way and will have to be cut off with a torch.
8. Screw the rod eye on until it is fully seated against the shoulder to the rod.
9. Replace the plastic plug and set screw.



Do **not** screw the set screw directly against the cylinder rod threads as they will be damaged and future removal of the rod eye will be impossible.
Do **not** use *Loctite* on the cylinder rod threads.

10. To bring the rod eye back into the correct orientation, place a pry bar in the rod eye hole and rotate the cylinder rod and rod eye clockwise.



Disassembling the Pressing Linkage

If the pressing linkage is damaged or requires rebuilding, it must be removed in a specific sequence as shown below:



- Forklift
- Wrench set
- Hex key set
- Pry bar set
- Oxy/Acetylene torch
- Clean rags
- Lifting chain
- Brass drifts
- 2x4 blocking
- Socket set
- 2 lb. hammer
- Sledge hammer
- Safety Glasses
- Fire extinguisher
- Lock and tag





1. Create a safe environment:
 - a) Check the oil temperature on the oil level/temperature gauge. Allow the oil to cool down to less than 100°F (38°C).
 - b) Place 2x4 blocking on each side of the table.
2. Move the platens to their extended position by performing these steps:
 - a) Start the machine.
 - b) Travel the press head over the blocking.
 - c) Move the joystick to the Down position to lower the pressing platen. Press the Stop button just as the platen reaches its lowest position and the hydraulic cylinder rod is fully extended. Do not build up any hydraulic pressure in the Down mode.

 WARNING	
 	<p>Do not remove any hose or valve without first:</p> <ol style="list-style-type: none"> 1) Lowering the platen so that it physically stops and is not being held up by hydraulic pressure; 2) Ensuring that no hydraulic pressure has built up in the system. 3) Wear eye protection and appropriate PPE. <p>Even with the machine turned off, the residual hydraulic pressure may cause serious injury.</p>



3. Lockout/tagout the main power to the machine.
4. Remove guards.
5. Clean and support the components:
 - a) Clean all sawdust, dirt and oil residue from the cylinder, hoses and area.
 - b) Position a forklift for the support and removal of the various components.
6. Remove the hoses:
 - a) Mark both cylinder hoses for future reference.



- b) Wrap rags around each of the two pressing cylinder hose fittings where they enter the cylinder.

	 WARNING
  	<p>Do not remove any hose or valve without first:</p> <ol style="list-style-type: none"> 1) Lowering the platen so that it physically stops and is not being held up by hydraulic pressure; 2) Ensuring that no hydraulic pressure has built up in the system. 3) Wear eye protection and appropriate PPE. <p>Even with the machine turned off, the residual hydraulic pressure may cause serious injury.</p>

- c) Carefully crack loose each hose fitting to remove any residual hydraulic pressure. Eye protection and protective clothing must be worn.
- d) Remove both cylinder hoses and place in a bucket



7. Remove the hydraulic pressing cylinder.



	 WARNING
	<p>Use extreme caution when using oxy/acetylene torch in the truss plant due to fire and/or explosion hazards. Consult a local fire marshall, if required.</p>

8. Remove the transfer bar:

- a) Using an oxy/acetylene torch, heat the transfer bar pin retaining bolt heads to break the *Loctite* bond.
- b) Remove the pin retaining bolts on the transfer bar.

	 CAUTION
	<p>The transfer bar weighs 170 lbs. Use a crane or other lifting assistance to lift and move it.</p>

- c) Using a brass drift, tap out the transfer bar pins. Then, lift off the transfer bar.

9. Remove the bellcrank pin's retaining bolts:



- a) Use an oxy/acetylene torch to heat up the bellcrank pin retaining bolt heads to break the *Loctite* bond.
- b) Remove the two retaining bolts in the bellcrank pin.
- c) Mark the two bellcrank pins for future reference.



A forklift is required to lift each bellcrank and connecting rod assembly out of the top platen.

10. Remove the bellcrank pin:

- a) Place a temporary pin or bar through the transfer bar pin hole in the top of the bellcrank.
- b) Place a chain from the forklift to the temporary pin.
- c) Gently take up the weight of the bellcrank assembly so that the main bellcrank pin can be rotated.
- d) Using a brass drift, carefully hammer the main bellcrank pin out of the upper platen.



 WARNING	
	Use extreme caution when using oxy/acetylene torch in the truss plant due to fire and/or explosion hazards. Consult a local fire marshal, if required.

11. Remove the lower connecting rod pin by using these steps:

- a) Use an oxy/acetylene torch to heat up the two lower connecting rod pin retaining bolt heads to break the *Loctite* bond.
- b) Remove the two lower connecting rod pin retaining bolts.
- c) Mark the two lower connecting rod pins for future reference.
- d) Use a pry bar to remove the lower connecting rod pins.



12. Using a forklift, lift the bellcrank/connecting rod assembly directly up and out of the upper platen.

 CAUTION	
	The bellcrank/rod assembly weighs 350 lbs. Use a crane or other lifting assistance to lift and move it.

13. Place the assembly on a workbench.
14. Remove the upper connecting rod pin by using these steps:
 - a) Use an oxy/acetylene torch to heat up the two upper connecting rod pin retaining bolt heads to break the *Loctite* bond.
 - b) Remove the two upper connecting rod pin retaining bolts.
 - c) Mark the two upper connecting rod pins for future reference.
 - d) Using a pry bar, remove the upper connecting rod pins.
15. Repeat the procedure with the other bellcrank.

Mechanical Inspection

Perform the following inspection every month.

1. Inspecting Fasteners and Pin Retaining Bolts

Vibration from pressing and hose surging may work some fasteners loose. A daily inspection of the entire machine should be done to locate any loose fasteners. Check the following items to ensure they are tight:

- a) Jam nuts on relief valve adjuster and unloading-valve adjuster.
- b) Jam nuts on the drive cushion valve adjusters.
- c) Pin retaining bolts holding press linkage pins in place.
 - If any pin retaining bolt is loose, remove the bolt, apply *Loctite* #262 to the threads and re-tighten.



2. Inspect Welds and Metal Components

Over the life of the machine, some of the highly stressed welds may occasionally develop fatigue cracks. It is best to catch it before the crack progresses and greater damage is incurred. Visually inspect the major welds. Any welds which have cracked must be repaired immediately by a qualified welder. Welds joining parts manufactured with high strength, heat treated steel require special welding techniques. Call MiTek for welding procedures.



Many machine components are manufactured from high carbon, heat-treated steel. Do not attempt to cold straighten, hot straighten, bend, or weld these components, as they may fail under load causing serious personal injury or death.

MiTek extends close technical cooperation and assistance. If a problem occurs which you cannot solve, please call MiTek for assistance. If you have any questions regarding the installation, operation or maintenance of this machine please consult MiTek.



Adjusting the Platen Height (Up Limit Switch)

PN

	 WARNING
	<p>CRUSH HAZARD.</p> <p>Before turning on the equipment, make sure that all personnel and equipment are clear.</p>





Socket set or
crescent wrench

Tape measure

Lock and tag

This limit switch controls the open height of the press, i.e., the distance from the top of the table surface to the bottom of the pressing platen. The platen height should be set at a position that allows for easy clearing of lumber and loose connector plates. For example, for roof trusses, set the open height at approximately 3"; for floor trusses, set the platen height at approximately 5". If the machine is set to the maximum platen height, the cycle time will be slightly longer when building roof trusses.

The Up limit switch and stop block are located under the dashboard, behind the end cover. The platen height is set by moving the stop block up or down using the procedure described in this section. See page 99 for the procedure and supporting graphic.

	 WARNING
	<p>Do not adjust the position of the stop block with the machine running. The machine will move automatically, causing serious personal injury.</p> <p>Lockout/tagout electrical and hydraulic system before performing any maintenance.</p>

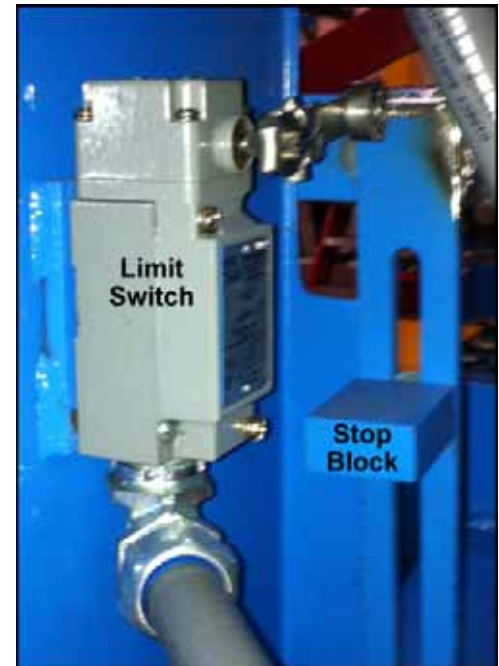

1. Measure the open height with the machine in the Up position.
2. Reach up near the dashboard and loosen the adjusting bolt on the stop block.
3. Raise or lower the stop block according to these guidelines:
 - If the open height needs to be increased by 1/2", lower the stop block 1/2" from its original position.
 - To decrease the open height by 1/2", raise the stop block 1/2".
4. Tighten the adjusting bolt on the stop block. The stop block must contact the bottom of the limit switch arm in the Up position.

Figure 7-11: Up Limit Switch

Start the machine and cycle. The platen will stop at the new height.



The limit switch must stop the upward travel of the platen before the hydraulic cylinder is in the fully retracted position. If it does not, the machine will remain in the Up mode under pressure and will not respond to the joystick control. Do not let the cylinder bottom out in the retracted position. There must be at least 1/2" of rod travel remaining in the Up position.



Track and Wipers

The track (outside flanges of the table beam) on which the wheels run must be kept clean of dust, oil, loose connector plates, etc. The following procedure is part of the *Periodic Cleaning Procedure* on page 113.

Figure 7-12: Track Wiper



1. Clean off the track and wipe it with a non-flammable solvent if oil is present.
2. Keep the 4 track wipers adjusted so that they brush sawdust and foreign particles off the track.
3. Traveling the machine on dirty tracks will cause the drive wheels to spin and skid which will cause premature wheel wear. A dirty track will also greatly increase the stopping distance.
4. Replace the wipers when they wear out.

PN



See page 121 for lubrication info.

Wheels & Rollers

Inspecting Drive and Idle Wheels

NOTICE	
	<p>Operating the machine with an undersized wheel will overload the remaining wheels and result in premature wear.</p>

The drive and idler wheels will wear out over time from being subjected to weight, torque, and mechanical damage.

The wheels must be inspected annually or at any time when the press head does not start or stop properly.



1. To inspect a wheel, remove the 4 bolts holding the wheel cover plate.
2. Remove the cover plate.
3. Inspect the wheel for cracks, cuts, or flat spots in the polyurethane. Wheels with large cracks, or wheels that clunk when the machine travels, should be replaced.
4. Measure the diameter of the wheel:



The diameter of a new wheel is 12". Wheels smaller than 11-3/4" in diameter are considered worn out. Wheels which are worn out may be re-treaded for less expense than buying a new wheel. Consult MiTek Machinery Customer Service for information.



Socket Set
Tape Measure
Lock and tag

- a) It is difficult to measure the diameter of the wheel directly, without first removing it. Instead, measure the height of the table beam, inside the flanges (i.e., 15-1/2").
 - b) Measure the distance from the top of the wheel to the inside of the top flange of the table beam (i.e., 3-1/2"). In this example, the wheel diameter is 15-1/2" minus 3-1/2" = 12" diameter.
5. If there is a spring present on the guide wheel camfollower, test that the spring is in working order.
 6. To replace a worn out or damaged wheel, refer to the procedure starting on page 103.
 7. Reinstall the cover plate and bolts when done.

Figure 7-13: Measuring the Inside Height of the Table Beam

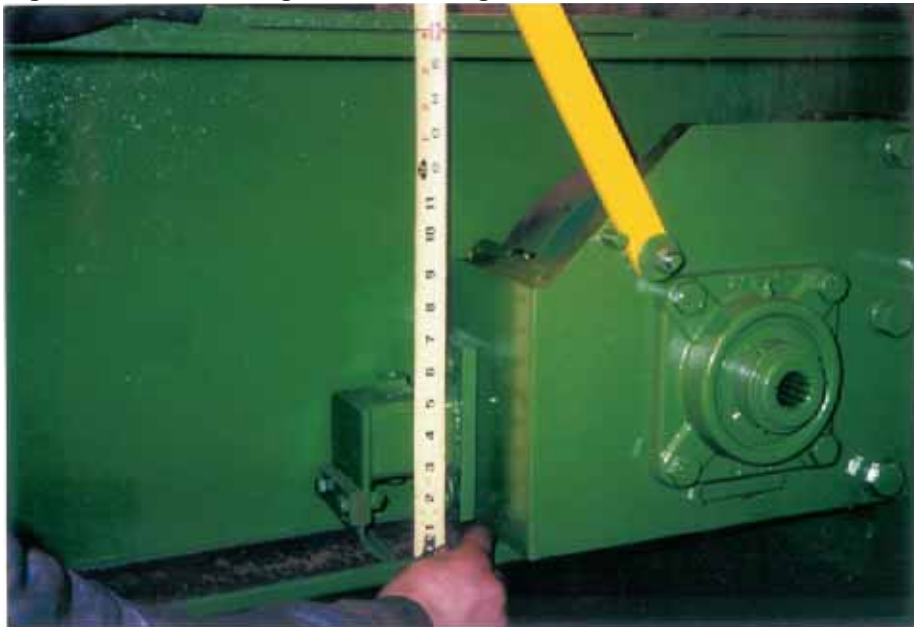

Measuring the Inside Height of the Table Beam

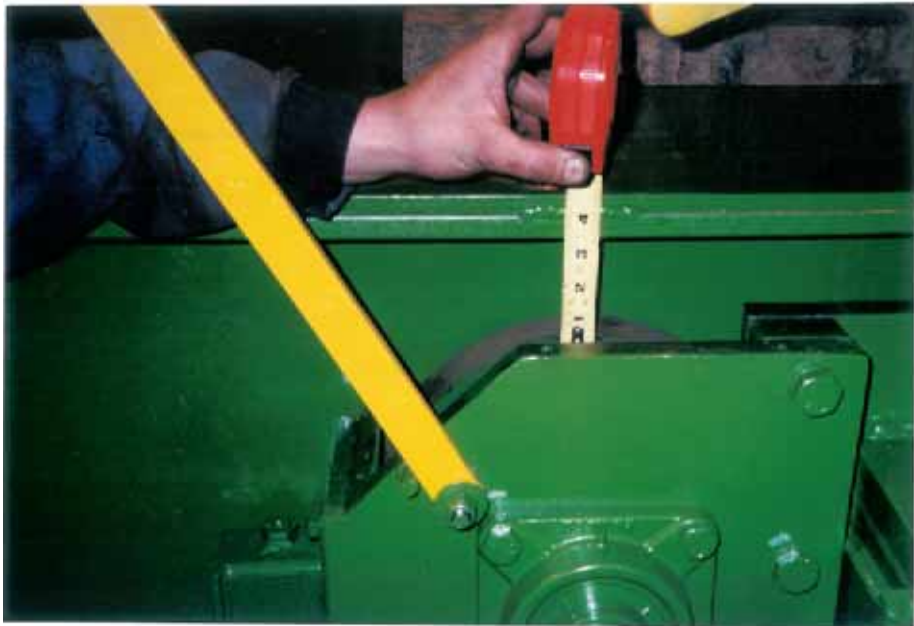

Measuring the Distance from the Top of the Wheel
to the Inside Top Beam Flange

Replacing a Drive or Idle Wheel

PN

Refer to *Parts List* appendix for the drive wheel and idler wheel part numbers.

The drive and idler wheels will wear out over time from being subjected to weight, torque, and mechanical damage. If the press head clunks or dog-tracks when it travels, the wheels should be inspected.



- Wheel
- Screwdriver Set
- Socket Set
- Combination Wrench Set
- Snap Ring Pliers
- Hex Key
- Loctite #242
- 2 Pry Bars
- Hydraulic Bottle Jack
- Torque Wrench
- 2 - 2x4 Blocking
- Grease
- Lock and tag

WARNING	
	<p>If the four wheels are not level with each other, the emergency stopping distance will increase to an unacceptable amount.</p> <p>The wheels must be level to each other and in good condition in order for the emergency stop circuits and travel braking valve to function correctly.</p>

The wheel must be replaced if:

- The polyurethane is cracked or damaged
- The wheel diameter is less than 11-3/4"
- The internal spline is damaged
- The bearing surfaces are worn out



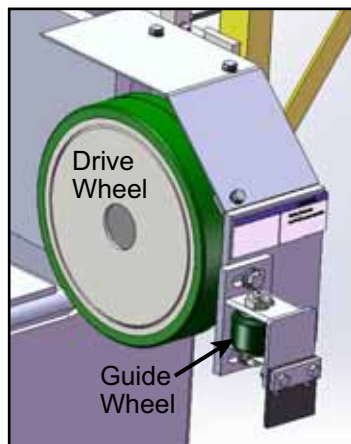

The drive and idle wheels are interchangeable. If a drive wheel internal spline becomes damaged, exchange it with a wheel mounted in the idle position.

Figure 7-14: Wheel Assembly



1. Check the oil temperature on the oil level/temperature gauge. Allow the oil to cool down to less than 100°F (38°C).
2. Lockout/tagout the main power to the machine.

	 WARNING
	<p>Only qualified hydraulic and electric experts should perform this adjustment.</p> <p>Always lockout/tagout the main power to the machine before making any mechanical, hydraulic or electrical adjustments or performing maintenance.</p> <p>High-voltage conductor rails located underneath the table can cause serious injury or death if contacted.</p>





3. If a drive wheel (NOT idler wheel) requires replacing:
 - a) Remove the four bolts holding the motor onto the motor mount.
 - b) Pull off the drive motor with the two hoses attached, being careful to pry the motor off evenly.
4. Jack the gantry head up to take weight off the wheels:
 - a) Place a hydraulic bottle jack under the guide rod on the side of the head with the damaged wheel. See Figure 7-17 on page 108.
 - b) Jack the head up approximately 1/4" until the lower frame contacts the table beam.

5. Remove the wheel by performing these steps:
 - a) Remove the 3 bolts holding the wheel gusset assembly to the press head. See Figure 7-15.

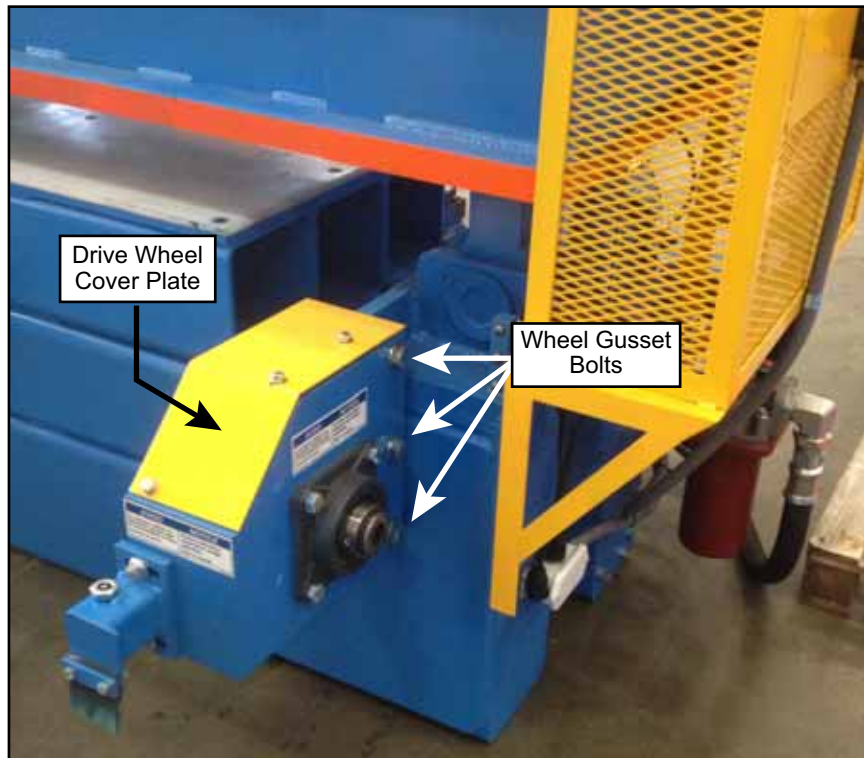
Figure 7-15: Replacing a Drive or Idle Wheel



- b) Remove the wheel gusset assembly and spacer plate.
- c) Remove the cover plate.
- d) Loosen the setscrew on each of the 2 bearing collars.
- e) Remove the exterior snap ring on the end of the wheel axle.
- f) Loosen the four bolts holding the 2 flange bearings together.

	 CAUTION
	2-man lift required. The wheel gusset assembly weighs 110 lbs.

- g) Slide the wheel out of the flange bearings.

6. Inspect the flange bearings for proper operation. Replace if necessary.
7. Install the new wheel into the flange bearings.
8. Before tightening the 4 bearing bolts, ensure that the bearing housings are touching the two stop blocks welded to the wheel gusset. The inside stop block is above the bearing housing. The outside stop block is below the bearing housing. These stop blocks keep the wheel aligned horizontally. If the wheel is a drive wheel, make sure that the drive motor slides on square to the mounting plate, before finally tightening the 4 bearing bolts.
9. Tighten the bearing bolts to 160 ft.-lb. torque.
10. Reassemble in the opposite order.
11. Level the four wheels to each other. (Refer to page 107.)

The wheel leveling procedure must be performed every time after a wheel is changed or if one drive wheel tends to spin or skid during traveling.

Leveling the Drive and Idle Wheels



Why and When to Level the Wheels



Two 3/16" x 2" flat bars x 30" long
 36" level
 2x4 blocking
 2 hydraulic bottle jacks
 Lock and tag

For the press head to travel properly, all 4 drive/idle wheels must be level with each other and with the head itself. If the wheels are not level, they will not be carrying the weight of the head equally and the more lightly loaded drive wheels will tend to spin and skid. This will cause the wheels to wear out prematurely and also cause the press head to dog-track.

The wheel leveling procedure must be performed every time a wheel is changed or if one drive wheel tends to spin or skid during traveling.



	 WARNING
	The wheels must be level to each other and in good condition in order for the emergency stop circuits and travel braking valve to function correctly.



The minimum wheel diameter is 11-3/4". A wheel smaller than this is worn out and should be replaced. (Refer to page 107.

How to Level the Wheels

1. Travel the press head to the left end of the table.
2. Lockout/tagout the equipment.

	 WARNING
	Only qualified personnel familiar with hydraulic and electric components and their hazards should perform this adjustment. Always lockout/tagout the main power to the machine before making any mechanical, hydraulic or electrical adjustments or performing maintenance. High-voltage electrical conductor rails located underneath the table can cause serious injury or death if contacted.

3. Place a 36" level across the width of the table at each end, to ensure that the two ends of the table are level with each other.

If the ends of the table are not level, place a permanent shim between the table base and the floor to remove any twist in the table.





4. Jack up the press head following these steps:

- a) Slide in one spacer between the machine frame and the underside of the table beam on each side of the machine. Each spacer must be 3/16" x 2" flat bar x 30" long.

Figure 7-16: Placing Spacer Between Beam and Frame

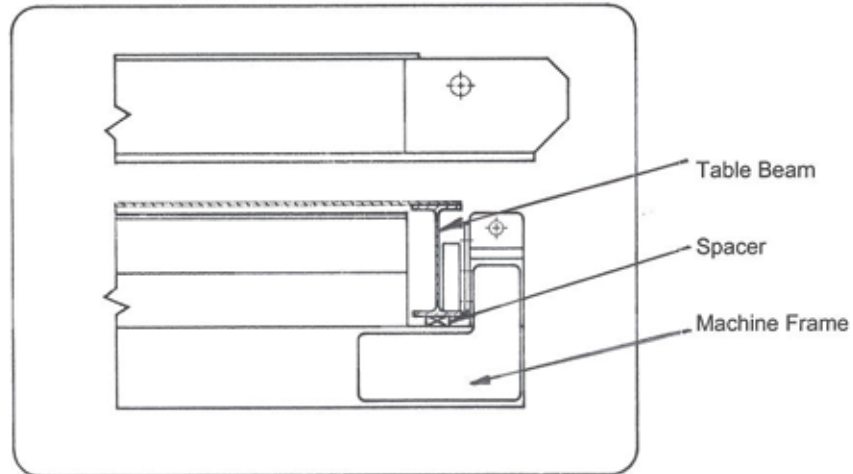

Placing Spacer Between Beam and Frame

- b) Locate the spacer parallel to the table and directly under the web of the table beam.
- c) Place a hydraulic bottle jack under guide rod on each end of the press head.

Figure 7-17: Lifting the Press Head



- d) Jack up the head on both sides until the 3/16"-thick spacers are held tightly between the press head and the table beams.



5. Lower the wheels:
 - a) Using a 1-in. socket and ratchet, loosen the three 3 bolts holding the wheel gusset to the press head. This will allow the wheel assembly to drop slightly so that the wheel touches the beam.
 - b) Re-tighten the three 3/4-in. diameter bolts to approximately 250 ft.-lb. of torque.
 - c) Repeat steps 5 for the three remaining wheel gussets. The head is now level with the table and all 4 wheels are positioned to contact the track evenly.
6. Lower and remove the hydraulic jacks.
7. Remove the two spacers from between the machine frame and table beams.
8. The press head is now set with a running clearance, between the frame and the table beam, of 1/4" (3/16" spacer plus 1/16" wheel compression = 1/4" total clearance) and the wheels are equally loaded.
9. Turn the main power back on and check to ensure that one drive wheel does not tend to spin when starting travel. If both drive wheels spin or skid, the cushion valve may be set too high.



Refer to...

page 120 for lubrication instructions.



- Socket set
- Steel wedges
- Safety glasses
- Sledge hammer
- Tape measure
- Large pry bar
- Hearing protection
- Lock and tag

Adjusting Guide Wheels for Gantry Head Tracking

	WARNING
	High-voltage electrical conductor rails located underneath the table can cause serious injury or death if contacted.

Four guide wheels are used to keep the head running square to the table. Two fixed guide wheels are located on the operator's side and two spring-loaded guide wheels are on the opposite side. All four guide wheels have adjustable mounting bases. If the head is not traveling square to the table, or if the head binds or slows down at mid-table, follow the adjustment procedure.

Figure 7-18: Top View of Spring-Loaded Guide Wheel

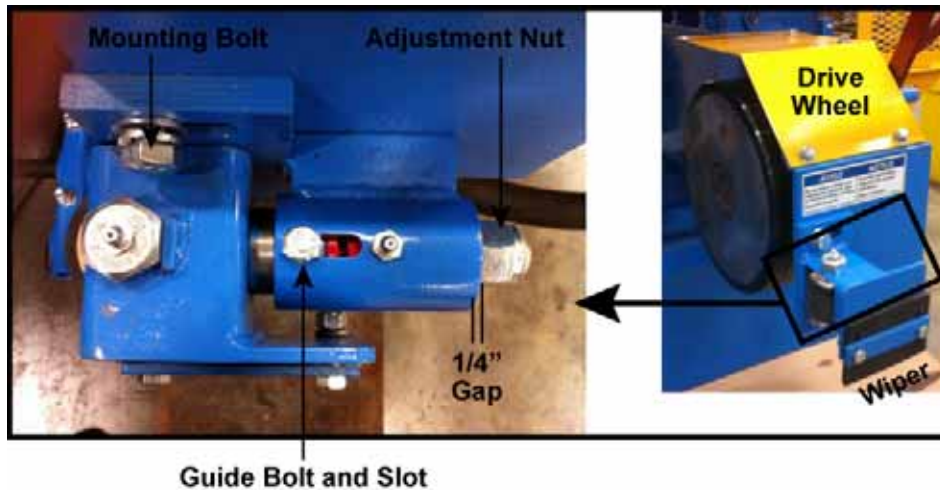

To adjust the guide wheels, follow these steps:



1. Travel the press head to the middle of the table span.
2. Lockout/tagout the main power to the machine.
3. Turn in (clockwise) the large adjustment nut on each of the spring-loaded guide wheels until the guide bolt is approximately at the middle of the guide slot. This will compress the spring and move the guide wheel away from the beam.
4. Loosen the two mounting bolts on all four guide wheel assemblies and slide the guide wheel assemblies away from the beams.

5. Measure the clearance between the machine frame and the table top at the four corners. Use a steel wedge and a sledge hammer or large pry bar to center the pressing head on the table. Place the wedge or pry bar between the wheel gussets and the side of the table top at the narrowest clearances. Pry or hammer the wedge in to slide the head of the machine over until the distance between the table and the four corners of the machine frame is equal. The press head is now sitting square to the table.
6. Slide the guide wheel assembly over, by hand, until the wheel is against the web of the table beam. Make sure the wheel is fully contacting the web, then tighten the two mounting bolts.
7. Repeat the procedure for the remaining three guide wheel assemblies.
8. Back off the large adjustment nut on each of the spring-loaded guide wheels approximately 1/4" to apply the correct pre-load.

PN

To replace the guide wheel, see the *Parts List* appendix.

Jigging

The jigging is designed for durability and accuracy with minimal maintenance. It is important, however, to promptly remove from service any damaged fixtures or components. Damage may occur if the jigging is hit with a heavy object, dropped on the floor, or from daily wear. If damaged components are not replaced immediately, they may cause damage to other threaded parts as well as inaccuracies in the trusses built with those components.

PN

It is a good idea to stock extra jigging to ensure the jigging in operation is in optimum condition. As part of your annual preventive maintenance, we recommend taking inventory of all jigging you are currently using or have in stock. Replace any damaged jigging at that time.

Cleaning

Daily Cleaning Procedure



NOTICE	
	<p>Never use compressed air inside the electrical enclosures! It may force contaminants into the electrical connections.</p> <p>Use a vacuum to remove dust from electrical enclosures. Canned air is acceptable after vacuuming</p>

1. Blow off all surfaces, including motor vents, slots, etc. Do NOT blow compressed air inside an electrical enclosure or electrical parts.
2. Wipe each scanner eye with a soft cloth.
3. Keep area around the machine free of scrap lumber, connector plates, sawdust, oil, etc.

Periodic Cleaning Procedure



The following cleaning procedure should be performed at least every 3 months.



1. Clean the entire machine. Do not use liquid cleaners, aerosols, abrasive pads, scouring powders or solvents, such as benzine or alcohol. Use a soft cloth lightly moistened with a mild detergent solution. Ensure the surface cleaned is fully dry before reconnecting power.
2. Clean off the wheels' track and wipe it with a non-flammable solvent if oil is present as described on page 100.
3. Clean the Electric Motor Vents and Fins
 - a) Using compressed air, blow off any sawdust which has accumulated on the electric motor vents and fins.
 - b) Travel the press head to the left-hand end of the table.
 - c) Lockout/tagout the main power to the machine.
 - d) Remove the left-hand table end cover.
 - e) Blow off the electric motor using compressed air.
 - f) Inspect the hydraulic system for oil leaks and loose fasteners.
 - g) Replace the left-hand table end cover.



Socket Set

NOTICE	
	<p>CRUSH AND CUT HAZARD</p> <p>Guards must always be in place during operation to avoid serious injury and possibly death.</p> <p>Always replace guards after maintenance is complete and before removing the lockout/tagout device.</p>

Lubrication

	 WARNING
	<p>The following must be greased daily to prevent premature machine wear and component failure leading to possible personal injury.</p> <p>Always turn off and lockout the main power to the machine before greasing.</p>

Proper amounts of motor oil and grease must be maintained at all times. The type of lubrication used, frequency of application, oxidation, and contamination of the lubricant affect service life and parts efficiency of gears and bearings. Improved performance will be obtained by following the guidelines in this manual. Lubrication guidelines are given in this chapter for each part or system that requires lubrication. The information is also in the *Maintenance Checklist* appendix.



Grease gun
Grease NLGI-EP#2
Lock and tag
Clean rags

There are synthetic fluids, synthetic blends, and hydrocarbon fluids (mineral). The synthetic fluids and synthetic blends are usually phosphate esters, chlorinated hydrocarbons, or a blend, sometimes including a small amount of hydrocarbon based oils. With these lubricants, special consideration must be given to the seals, pump performance, paints and any plastics in the system. In addition, the viscosity of synthetic fluids and synthetic blends is usually much lower than the viscosity of hydrocarbon (mineral) based fluids. The end result of the oil quality is unintelligible.

	NOTICE
	<p>Mixing synthetic lubricants with mineral lubricants is not recommended. Check with your lubricant supplier</p> <p>Never mix different types of grease.</p>

The linkage of the press utilizes many bronze bushings which must be kept well lubricated. They must be greased daily with an extreme-pressure grease such as NLGI #2 lithium grease. Failure to do so can cause binding and serious damage to your press and will void the warranty.

Brass shavings around the linkage pins and broken pin locks are indicators of insufficient greasing. Use the following procedure to lubricate all components discussed in this section:



1. Clean off the grease fitting with a rag so that dirt will not be pushed into the bushing.
2. Using a grease gun, pump four to six strokes into each grease fitting.
3. Wipe off excess grease from all fittings.

Use Table 7-4 along with the diagram on page 116 to locate all lubrication points. The frequency of lubrication is discussed in the text applicable to each component.

Table 7-4: Description of Lubrication Points

Label	Lube Point Name	Quantity
1	Transfer bar rod eye	1 per end
2	Grease block: Bellcrank and upper connecting rod	1
3	Cylinder rod eye	1
4	Cylinder clevis	1
5	Grease block: Lower connecting rod and guide rod	1 block per end
6	Guide Wheel axles	2 per end
7	Spring-loaded guide wheel	2 on op end
8	Table guide roller bearings	See page 123
Drive or Idler	Drive or idler wheel bearings	See page 121

These numbers correspond to the procedural steps and the labels in Figure 7-19.

Figure 7-19: Lubrication Points

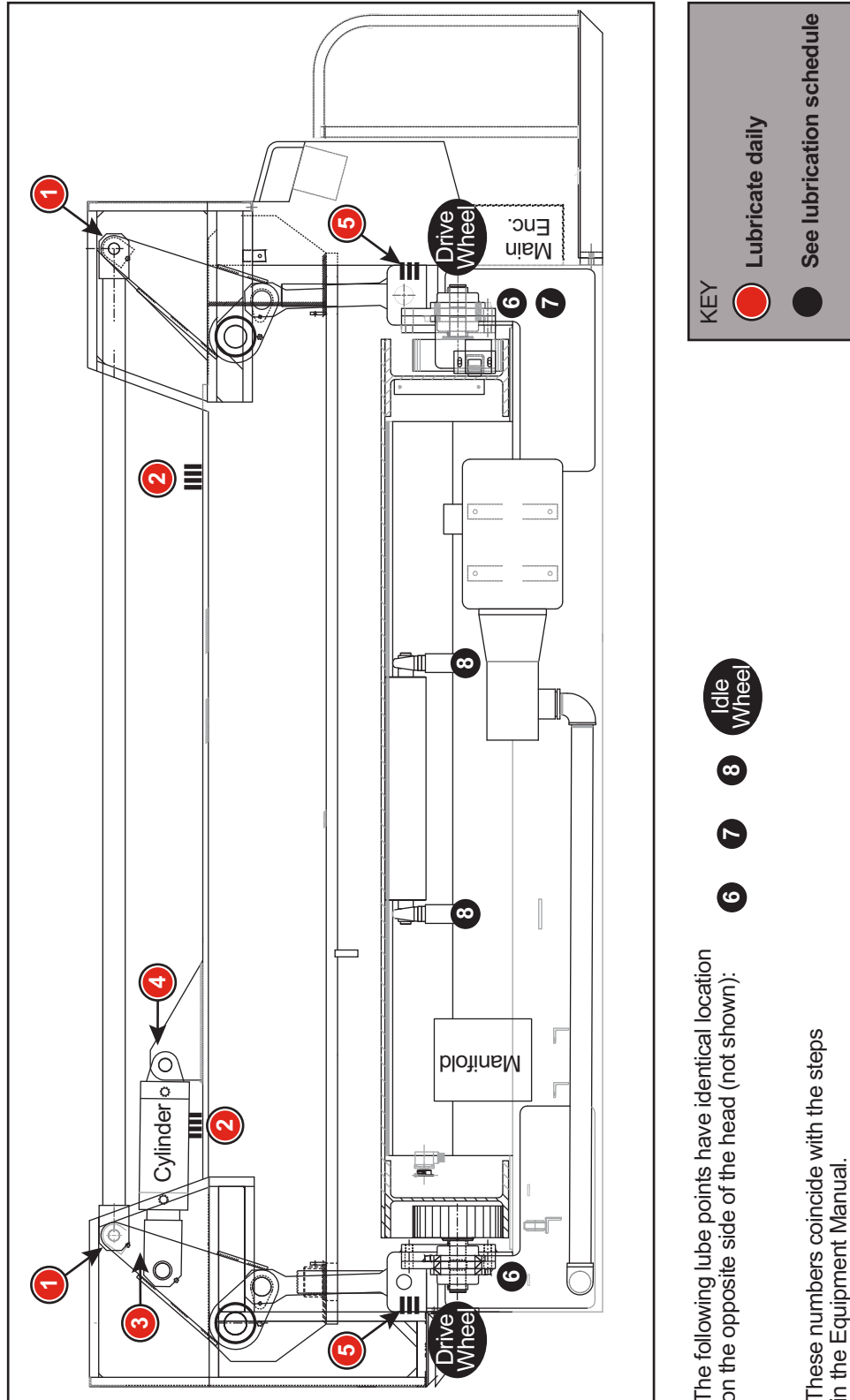

The following lube points have identical location on the opposite side of the head (not shown):

- 6
- 7
- 8
- Idle Wheel

These numbers coincide with the steps in the Equipment Manual.

Lubricate Daily

Refer to page 115 and page 116 for an overview and map of lubrication points. The numbers here correspond to the numbers in Figure 7-19.



1. Transfer bar rod eye (qty 2)

There is 1 transfer bar rod eye grease fitting per end. Apply grease daily.

Figure 7-20: Transfer Bar Rod Eye Grease Fitting



2. Grease blocks on top (4 fittings ea X 2 blocks)

Figure 7-21: Grease Block for Bellcrank and Upper Connecting Rod Lubrication (2 places)

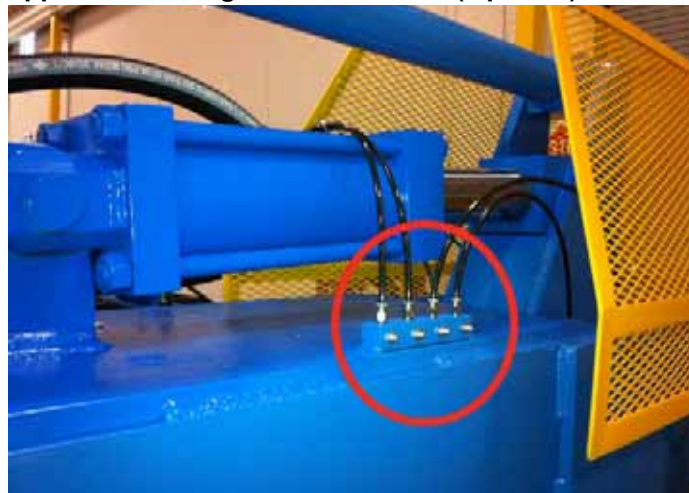



3. Cylinder rod eye (qty 1)

There is 1 cylinder rod eye grease fitting. Apply grease daily.

Figure 7-22: Cylinder Rod Eye Grease Fitting

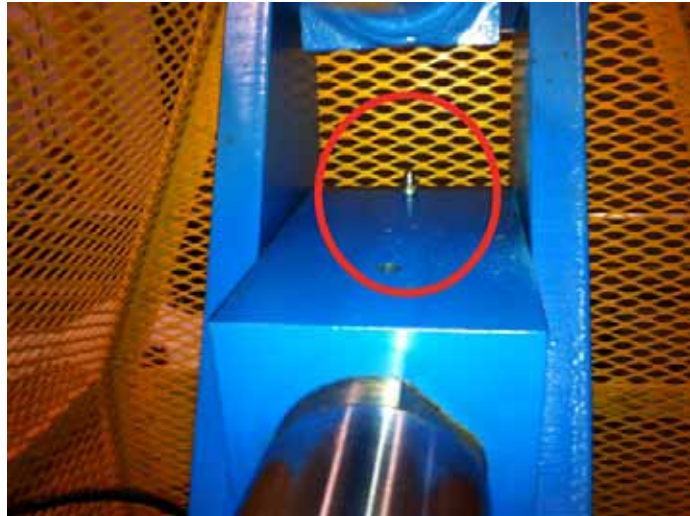

4. Cylinder clevis (qty 1)

There is 1 cylinder clevis grease fitting. Apply grease daily.

Figure 7-23: Cylinder Clevis Grease Fitting







5. Grease blocks on each end (3 fittings each X 2 blocks)

There are 2 grease blocks, 1 on each end, that provide grease to the lower connecting rod and guide rod. Apply grease daily.

Figure 7-24: Grease Block for Lower Connecting Rod and Guide Rod (2 places)



Lubricate Weekly

 WARNING	
	<p>The following must be greased weekly to prevent premature machine wear and component failure leading to possible personal injury.</p> <p>Always turn off and lockout the main power to the machine before greasing.</p>



6. Guide Wheel axle (qty 4)

There are 4 guide wheels located on the press head to keep it from dog-tracking as it travels along the table. They are camfollower-style wheels. All four guide wheels should be greased weekly by applying grease through the grease fitting on top of the axle shaft. Do not get grease on the rolling surface of the wheel.

Check all four guide wheels to ensure that they are in contact with the track web, that they rotate as the head moves, and that there are no flat spots on the wheel face. (Refer to the Adjustments Section, page 183, for guide wheel adjustments.)

Figure 7-25: Guide Wheel Axle and Spring Grease Fitting

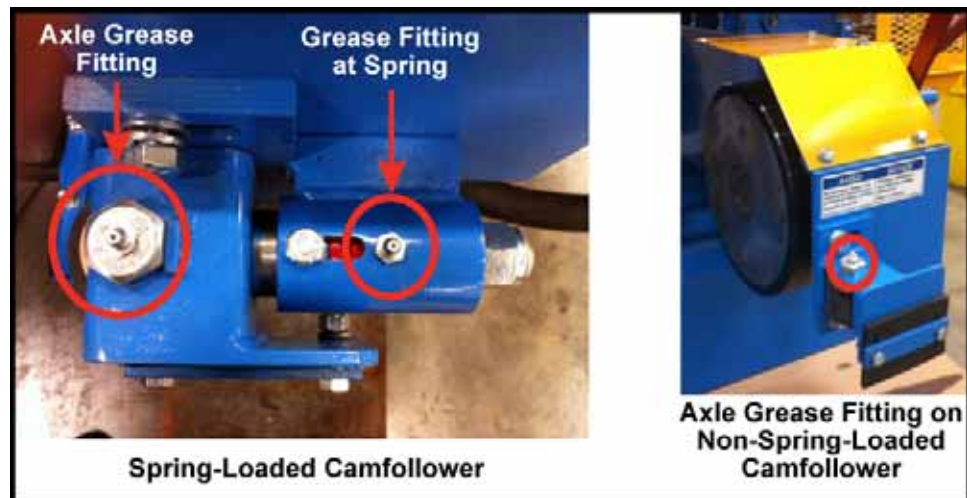

7. Spring-loaded guide wheel (qty 2)

There are 2 grease fittings on the operator's end for the spring-loaded guide wheel. Only 2 of the 4 guide wheels are spring loaded. The two spring-loaded guide wheels have a grease fitting on the telescoping section, shown in Figure 7-25. Ensure there is sufficient grease to allow for ease of movement.



See page 116 for location of lube points. See page 122 for photos of a drive wheel bearing.

Lubricating Drive and Idle Wheel Bearings

There are two flange bearings on each wheel which require greasing every 12 months. One bearing is accessible from the outside. The other bearing necessitates the removal of the wheel cover plates on the wheel gussets. The visible bearing and the wheel cover plate is shown in Figure 7-26 on page 122. The overall location is shown on the lubrication diagram on page 116.

The factory-supplied grease for most sealed ball bearing units is NLGI #2 lithium grease. Unfortunately, these two types of grease are not compatible with each other. If you are unsure of the existing type of grease, carefully fill the bearing until all the old grease is purged out through the seals and a small bead of new grease is evident at the seals. Always use the same type of grease.

Refer to the steps later in this section for the lubrication procedure.

NOTICE	
	<p>Mixing synthetic lubricants with mineral lubricants is not recommended. Check with your lubricant supplier</p> <p>Never mix different types of grease.</p>



- Socket Set
- Grease Gun
- Loctite #242
- Grease
- Clean Rags
- Lock and tag

On low speed applications such as this, it is acceptable to entirely fill the bearing with grease. (On high speed applications, the bearing will overheat if it is filled more than half full.)

Figure 7-26: Lubricating the Drive/Idle Wheel Bearings

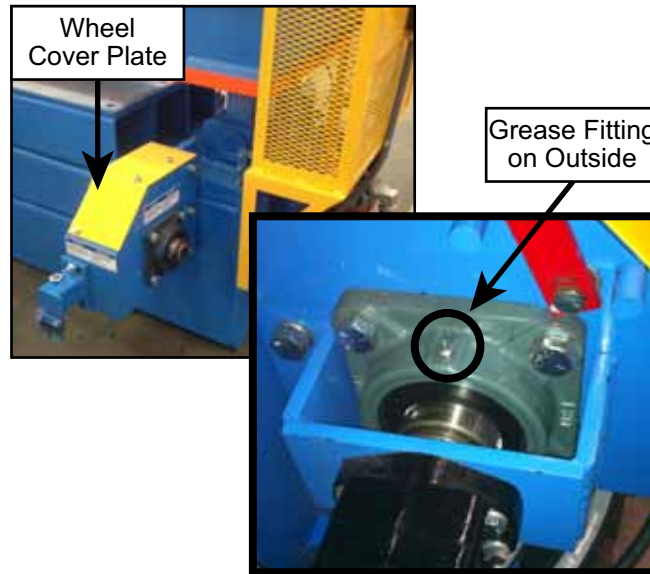

1. Remove the wheel cover plate.
2. Clean off the grease fitting on each of the two wheel bearings, using a rag to remove any dirt.
3. Using a grease gun, displace grease into the bearing until a small bead of new grease is evident under the seals.
4. Wipe off any excess grease.
5. Check the setscrew on the bearing collar to ensure it is tight.
6. If the setscrew is loose, remove it. Apply *Loctite* #242 to the setscrew and replace.
7. Replace the wheel cover plate.
8. Repeat the procedure for the remaining three wheels.





- Socket Set
- Grease Gun
- Loctite #242
- NLGI #2 lithium grease
- Clean Rags
- Lock and tag

Lubricating Table Guide Roller Bearings

The table guide roller bearings require grease every 12 months.

1. Start the machine.
2. Travel the machine to the left end of the table.
3. Lockout/tagout the main power to the machine.

 WARNING	
	<p>Always turn off and lockout the main power to the machine before making any mechanical, hydraulic or electrical adjustments or performing maintenance.</p> <p>High-voltage electrical conductor rails located underneath the table can cause serious injury or death if contacted.</p>

4. Remove the left end cover from the table to access the grease fittings on the left-hand guide roller bearings.
5. Clean off the grease fitting on each of the two pillow block bearings.
6. Using a grease gun, displace grease into the bearing until a small bead of new grease is evident under the seals.



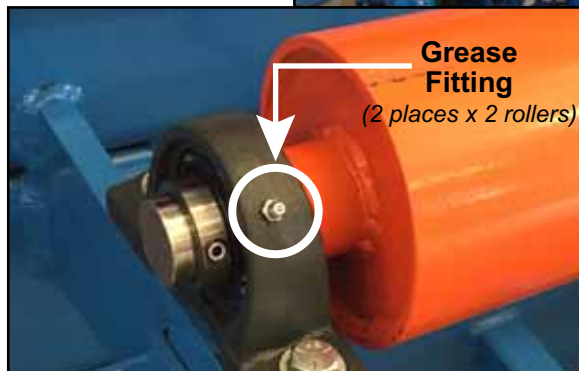

Figure 7-27: Table Guide Roller and Bearing



See page 116 for location of lube points.

7. Wipe off any excess grease.
8. Check the setscrew on the bearing collar to ensure it is tight.
9. If the setscrew is loose, remove it. Apply *Loctite* #242 to the setscrew and replace.
10. Inspect the table guide roller for wear and table clearance. The guide roller should hold the table top from 1/8" to 3/16" above the lower platen wear pad.
11. Replace the left-hand table end cover.
12. Repeat this procedure for the right-hand guide roller.

Solutions for Inadequate Stopping Distance

	 WARNING
	<p>Never operate the press if the stopping distance exceeds the recommended measurement. A safe stopping distance is required for the safety devices to respond appropriately.</p>

Stopping distance will increase depending upon the following conditions:

- The levelness of the press head and wheels. If the four wheels are not level with each other, the emergency stopping distance will increase to an unacceptable amount. (Refer to page 107 to level the wheels.)
- Cleanliness of the track. Dust or oil on the track will increase the stopping distance.
- Condition of the drive wheels. Worn, damaged, or undersized wheels will increase the stopping distance. (Refer to page 103 to replace the wheels.)
- The levelness of the table. If the table is not level end to end, the stopping distance will be increased.

If, during testing, you find that the press does not stop within the proper distance, contact MiTek immediately.

	NOTICE
	<p>Do not use the safety shutoff bars or E-stop buttons as a substitute for turning off the press. They are designed for emergency situations only and place high stress on drive line components. Always use the STOP button on the dashboard for turning off the press.</p> <p>Activating the safety shut-off bar system places a very high stress on the drive system. After testing, have hydraulics maintenance personnel inspect the travel hoses, drive motors and valves, to ensure there are no hydraulic leaks. Repair any leaks immediately, if found.</p>



Replacing a Drive Motor



Motor
 2 Pry Bars
 Grease Gun
 Socket Set
 Drain Pan
 Wrench Set
 Clean Rags
 Lock and tag
 Hearing protection

There are 2 drive motors that control horizontal travel of the press head. They are powered by hydraulic power. A drive motor may need to be replaced if an oil leak is present or if the external spline shaft or internal motor components are damaged. The procedure for replacing a drive motor is as follows:

1. Check the oil temperature on the oil level/temperature gauge. Allow the oil to cool down to less than 100°F (38°C).
2. Start the machine.
3. Move the joystick to the Down position to lower the pressing platen. Press the STOP button just as the platen reaches its lowest position and the hydraulic cylinder rod is fully extended. Do not build up any hydraulic pressure in the Down mode.
4. Turn off and lockout the main power to the machine.



 WARNING	
	<p>Only qualified personnel familiar with hydraulic and electric components and their hazards should perform this adjustment.</p> <p>Always lockout/tagout the main power to the machine before making any mechanical, hydraulic or electrical adjustments or performing maintenance.</p> <p>High-voltage electrical conductor rails located underneath the table can cause serious injury or death if contacted.</p>



5. Clean off the motor and hose ends.
6. Mark hose locations for future reference.
7. Drain the hydraulic fluid reservoir, then place a drain pan under the motor, to catch the small amount of oil which will be in the motor and hoses.



8. Wrap a rag around each hose fitting to contain any residual hydraulic pressure before loosening it.

 WARNING	
 	<p>Do not remove any hose or valve without first:</p> <ol style="list-style-type: none"> 1) Lowering the platen so that it physically stops and is not being held up by hydraulic pressure; 2) Ensuring that no hydraulic pressure has built up in the system. <p>Even with the machine turned off, the residual hydraulic pressure may cause serious injury.</p>

9. Undo the hoses and place the ends in a drain pan.
10. Remove the four bolts holding the motor onto the motor mount.



Pry off the motor evenly.

11. Carefully pull off the drive motor.
12. Inspect splines on motor shaft and internal splines on drive shaft for wear.
13. Apply a thin coat of grease to the splines on the new motor.
14. Align the splines and push the motor directly onto the motor mount.

The motor should slide on with relative ease. Do not hammer on the end of the motor. If resistance is encountered, remove the motor and inspect.

15. Rotate motor housing to line up mount bolt holes.

The mounting surface of the motor must be flush with the motor mounting plate. If the motor does not sit square, the wheel bearings are slightly misaligned (refer to page 107). Do not pull in the motor using the mountings bolts, as this will cause the motor shaft to fail.

16. Replace the four motor mount bolts.
17. Torque bolts to 50 ft.-lb.
18. Replace hoses in correct locations.

Maintaining Electrical & Safety Assemblies

Maintaining the Scanner

Scan Area

The scanner surveys the area from the press head surface to approximately 32 in. out from the front/back of the press head. It extends to the furthest most point on the ends of the gantry head which is the operator platform on one end and the end guard on the opposite end.

Ensure that the table and floor in this area are kept clean and free of obstacles inside the scan area. The scan area can not be adjusted. It is set by MiTek to cover an appropriate area to keep all personnel safe.

Scanner Sensors

The scanners' sensors must be kept clean and dust-free. A light on the operator dashboard indicates when a left or right scanner sensor needs cleaning.

Scanner Sequence of Events

When a scanner detects an obstacle or unsafe condition, it shuts down the safety valve which halts horizontal travel in that direction. This is an E-stop condition.

Restarting After a Scanner Activation

The START button on the dashboard causes the electric motor to start up, but only after it the system checks that all safety systems are in a Ready state. After a scanner is activated, the START button will only reset the safety circuit after the obstacle has been cleared. If necessary, move the gantry head in the opposite direction by pressing and holding the START button. Once the obstacle is cleared, press and release the START button, and operation can resume.

Indicator Lights

Indicator lights on the dashboard are described on page 46.



Replacing Horn and Beacon

Figure 7-28: Travel Warning Horn and Beacon

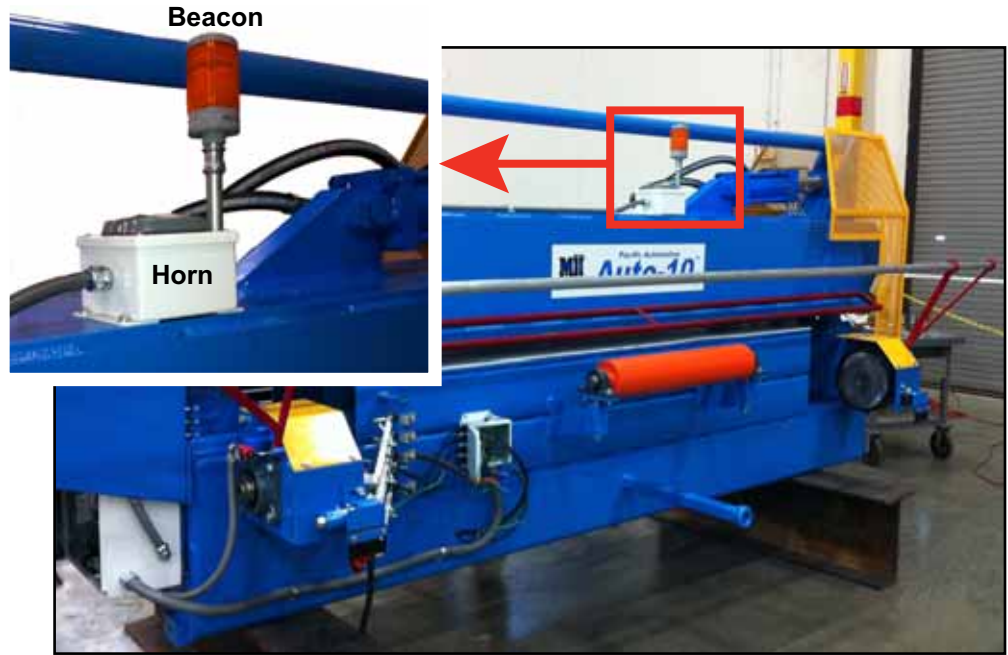

- Screwdriver Set
- Lock and tag
- Strobe Bulb



	 WARNING
	<p>Do not operate the equipment if the beacon is not functioning correctly.</p>



1. Place the pins on the bottom of the lens into the sockets located on the beacon tower base.
2. Push in the captive key until all 4 pins on the captive key slide completely into the 4 plastic loops showing through the bottom of the lens. You will hear it snap in place.
3. Slide the light source into the lens so that the 4 pins on the back side of the light source slide into the port mounted inside the lens.
4. Put the lens cover over the open side of the lens and screw in place.
5. Screw the lens top in place.

If neither the light nor the horn work, have a licensed electrician check the control circuit.

Figure 8: Assembling the Light

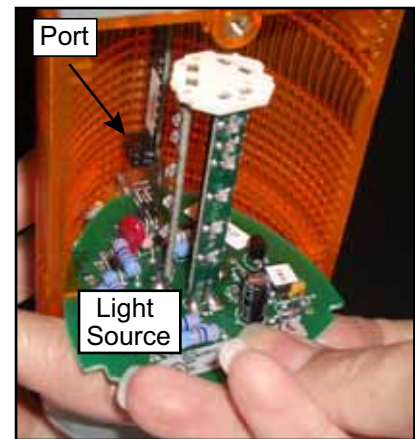
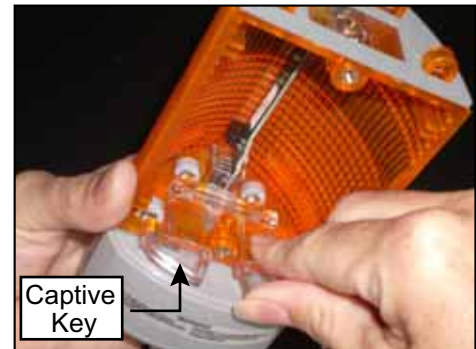

Maintaining Electrical Track Components



Screwdriver set

Socket set

Channel lock
pliers

Pickup arm shoes

Conductor rail
(10 ft)

Lock and tag

Caring for Track Components

The electrical track components will wear out over time and require servicing. To achieve maximum life from these components, the following conditions must be met:

1. The conductor rails to the machine must be straight and level.
2. The conductor rails must be kept clean.
3. The collectors must be set at the correct tension, which is at the midpoint of travel.



If the electrical pickups or conductor rails start to 'arc' at one location, they should be replaced before a dead zone is created.

Replacing Collector Shoes

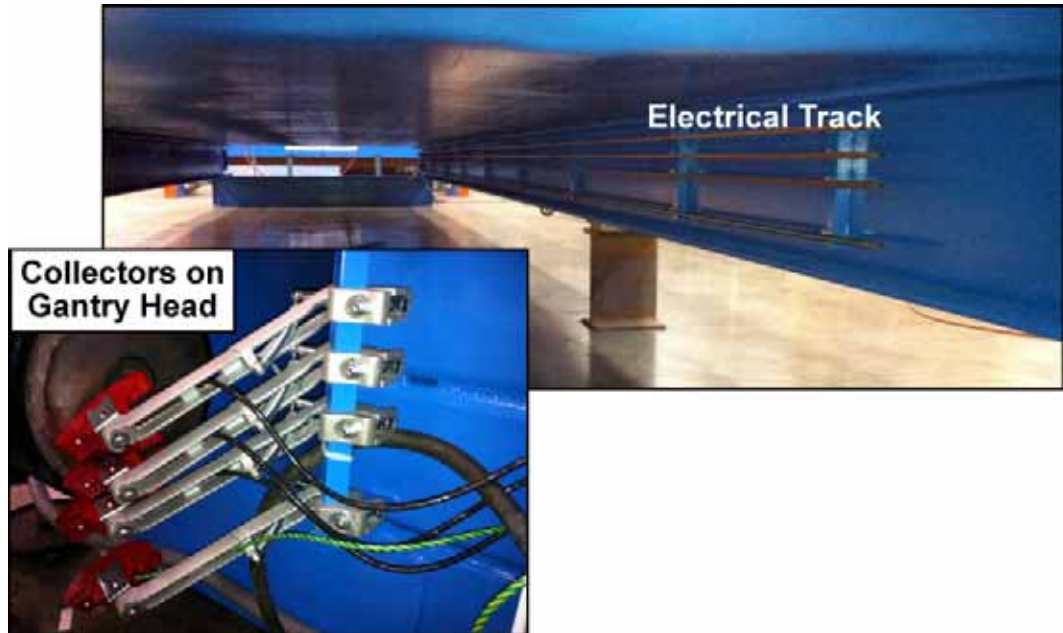
Figure 7-1: Collectors and Electrical Track



Use the following procedure to replace collector shoes:



 WARNING	
	<p>Only qualified personnel familiar with hydraulic and electric components and their hazards should perform this adjustment.</p> <p>Always lockout/tagout the main power to the machine before making any mechanical, hydraulic or electrical adjustments or performing maintenance.</p> <p>High-voltage electrical conductor rails located underneath the table can cause serious injury or death if contacted.</p>



1. After locking out the equipment, unbolt the collectors from the 1-in. square bar.
2. Bend the two tabs, which hold the plastic cover to the arm, outward and remove the case.
3. Remove the two screws holding the two halves of the plastic case together, and separate the case.
4. Remove the brass shoe from the case.
5. Undo the bolt holding the wire terminal end to the shoe.
6. Bolt the wire onto the new shoe and reassemble in the opposite order.

Replacing a Section of the Conductor Rail

Use the following procedure to replace a section of electrical conductor rail:

	 WARNING
	<p>Only qualified personnel familiar with hydraulic and electric components and their hazards should perform this adjustment.</p> <p>Always lockout/tagout the main power to the machine before making any mechanical, hydraulic or electrical adjustments or performing maintenance.</p> <p>High-voltage electrical conductor rails located underneath the table can cause serious injury or death if contacted.</p>



1. After locking out the equipment, remove the two splice covers from the ends of the damaged 10' conductor rail which requires replacing.
2. If the damaged section of rail is in the middle of the track, the rail clamps must be loosened in order to slide the good rail out of the way.
3. Loosen the rail clamps from the closest end of the track to the damaged section.
4. Using a screwdriver, pry the joints apart on the damaged section and slide the good rails over so that the damaged section can be removed.
5. Install the new section of conductor rail.
6. Reassemble in opposite order.



The lower connector rail (green) is the Ground or Protective Earth (PE) conductor.

Electrical System Components



Electrical Inspection



Screwdriver Set
Ohm/Voltmeter
Lock and tag



Over a period of time, vibration may cause some of the electrical screws to work loose. Any evidence of heat, such as discolored insulation on a wire or component, would indicate that connection is loose. Left alone, a loose connection will get hot enough to melt the wires and components and possibly start a fire. Perform this inspection once a year or every 2,000 working hours.

	 WARNING
	<p>Only licensed electricians must be allowed to perform electrical services.</p> <p>Always turn off and lockout the main power to the machine before making any mechanical, hydraulic or electrical adjustments or performing maintenance.</p> <p>High-voltage electricity located inside panels and throughout the machine can cause serious injury or death if contacted.</p>

1. After lockout out the electrical power, open the table disconnect enclosure.
2. Check the main terminals with a voltmeter, to ensure no voltage exists.
3. Check each of the terminal screws on the table disconnect switch, to ensure that they are tight.
4. Open the main electrical enclosure under the dashboard.
5. Remove the plastic protective covers and check each screw on the electrical components and terminal strips to ensure that they are tight.



Pay particular attention to the high-voltage terminal screws on the top and bottom of the magnetic starters and overload blocks. If any of these screws work loose, the connection will arc and overheat. This may burn the wire and terminals. Check the two screws holding each of the three overloads in place, to ensure they are tight.

6. Replace the plastic protective covers over the terminals of the electric components.
7. Inspect the electrical conductor rails, rail clamps, and the collectors located under the table.
8. If any components or wires show evidence of overheating, they must be replaced.

Motor Overload Settings

Resetting an Overload Trip

If the overload trips, wait 2-4 minutes, and then press the red knob on the overload. It is labeled *Reset* in Figure 7-2.

Overload Settings

The motor overloads are factory set and should not require adjusting. If, for some reason, the default adjustment is lost, refer to this section.

- Automatic/Manual Setting

The red knob, labeled *Reset* in Figure 7-2, must be set to the Manual (M) setting.

- Amperage Range Setting

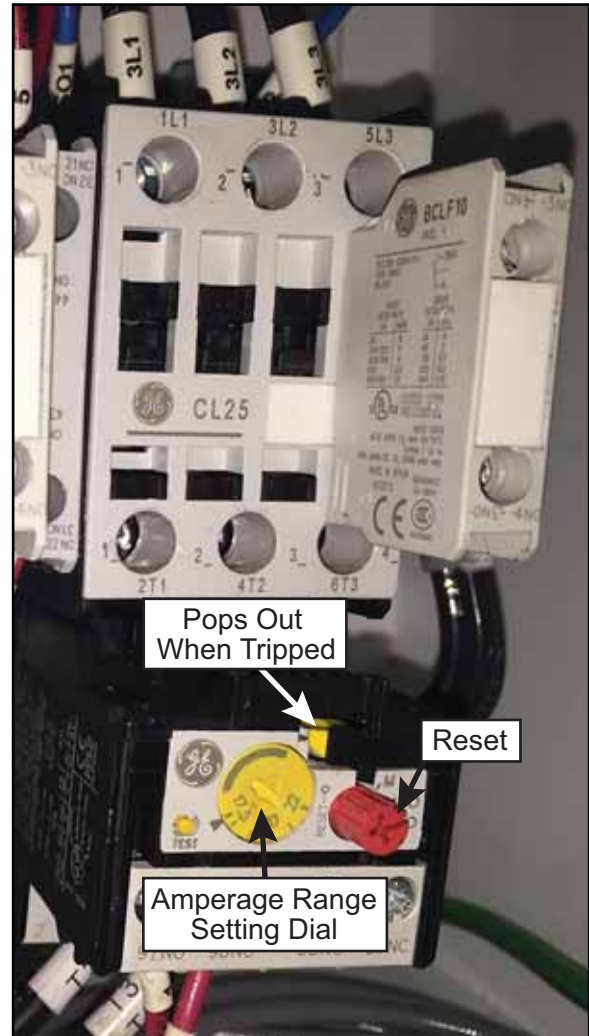

The yellow dial in Figure 7-2 must be set to the corresponding amperage draw of the electrical motors in order to offer protection. This value should equal the FLA listed on the motor multiplied by 1.25.

Figure 7-2: Overload Settings





Replacing the Control Power On Light

If the green CONTROL POWER ON light does not come on and the machine still operates, the light bulb is burned out and must be replaced.

	 WARNING
	<p>Do not operate the equipment if the CONTROL POWER ON light is not functioning correctly.</p>

Pneumatic System

	 CAUTION
	<p>HIGH PRESSURE HAZARD.</p> <p>To avoid injury, bleed all pressure from the lines before performing any maintenance on the pneumatic components!</p>

Overview

The pneumatic system controls the floor truss jiggling. For systems that do not have the floor truss jiggling option, there is no pneumatic air used on the machine.

Refer to your pneumatic drawing for diagrams and individual component information.

Figure 7-3: Pneumatic Components

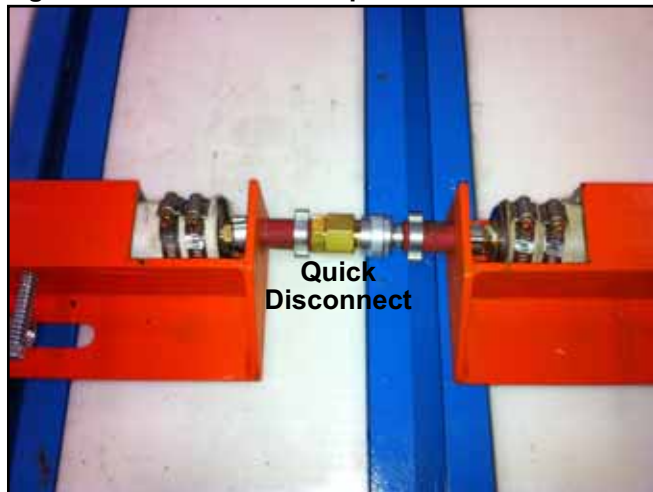

Regulator



	 CAUTION
	<p>HIGH PRESSURE HAZARD.</p> <p>To avoid injury, bleed all pressure from the lines before removing the filter guard.</p> <p>Ensure that the filter guard is securely attached to the regulator body before returning pressure to the lines.</p>

Figure 7-4: Filter/Regulator and Hand Valve



Adjusting the Air Pressure at the Regulator

Pull up on the knob above the gauge up and twist the knob to adjust the incoming air pressure. Operating pressure should be 20 psi.

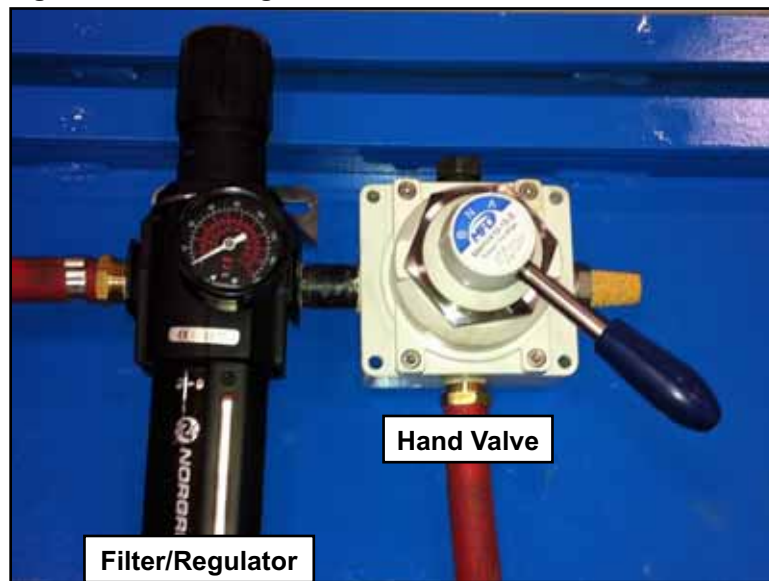
- Turn the knob clockwise to increase the pressure.
- Turn the knob counterclockwise to decrease the pressure.

When finished, push the knob back down.

Replacing the Pneumatic Filter Element

PN

The regulator uses a filter element that must be replaced every 6 months. This filter can be purchased from MiTek. Refer to the Replacement Parts appendix for the part number.

1. When replacing the filter element, the system cannot be pressurized. To relieve pressure from the system:
 - a) Close the hand valve shown in Figure 7-4.
 - b) Bleed the pressure from all the lines and lockout/tagout (If the regulator doesn't have a hole for the lock and tag, create a sign or restraint).
 - c) Ensure the gauge reads "0" before unscrewing the filter guard.
2. Remove the bowl from the regulator body by twisting approximately 1/4 turn clockwise while pushing up on the filter guard. Then pull down and remove the filter guard from the body.
3. Unscrew the filter element and remove it from the regulator. Be sure to keep the spring that is resting in the filter element.
4. Place the spring in the new filter element.
5. Screw the new filter element in its place.
6. Place the bowl back onto the regulator body by pushing up and turning counterclockwise. Make sure it is securely attached before returning pressure to the lines.

Manual Drain

Condensation can form in pneumatic lines due to temperature changes. When condensation gathers, it will show up in the bowl's sight glass. Where the sight glass comes in contact with water, it turns red, indicating the water level. The drain is normally open. There should be only a few drops of water per shift. If condensation becomes a serious problem, an air dryer is available.

Additional Maintenance

If a regulator is not operating at its optimum capacity, we recommend cleaning the regulator and replacing the O-rings, gaskets, diaphragm, and valve assembly. Order a service kit including these preventive maintenance parts from the regulator manufacturer.





Troubleshooting Unusual Noises

The press should run smoothly and quietly. An unusual noise could indicate a problem with the hydraulic system or drive system. If the machine “clunks” at one particular location on the table, lockout/tagout, then check to ensure that a jig bolt is not protruding below the table surface. Always use the correct length of jig bolt with the appropriate number of washers.

Safety Notes for Troubleshooting

Refer to...

Maintenance chapter for procedures and graphics
General Information chapter for truss terminology
Glossary for additional terminology
Page 3 to contact MiTek Machinery Division Customer Service

General Troubleshooting Safety Tips

	 WARNING
	<p>ELECTROCUTION, HIGH PRESSURE, CRUSH, CUT, AND CHEMICAL HAZARDS!</p> <p>Read all notes in this section AND the safety section in the preliminary pages before operating or maintaining this equipment.</p> <p>Most solutions are described in more detail in the <i>Maintenance</i> chapter and may have more safety notes included there.</p>

- **Read all warnings** located in the safety section in the preliminary pages and adhere to them at all times.
- **When this graphic appears, lockout/tagout at the disconnect switch located on the equipment** using approved methods described in OSHA 29 CFR 1910.147 before continuing with the procedure or troubleshooting.
- If the lockout/tagout graphic does not appear, it is recommended that you still **de-energize the machine** unless energy is required for the troubleshooting process. If it is absolutely necessary to troubleshoot an energized machine, follow NFPA 70E for proper procedures and personal protective equipment.
- **All electrical work must be performed by a licensed electrician.**
- **Read this manual** for information and procedures related to the specific maintenance or troubleshooting issue before attempting any maintenance!
- **Safety goggles and a dust mask** must be worn for all cleaning steps outlined in this manual. When using cleaning and lubrication solutions, a respirator rated for use with those solutions must be worn as well as gloves resistant to the solution.



Electrical Troubleshooting Safety Tips

- **Make sure you have the proper tools needed for the job.** See *Tools Needed* on page 143.
- **Ensure the person performing the troubleshooting is qualified** from an electrical knowledge standpoint. If you feel uncertain about troubleshooting

electrical power, remember, the cost of hiring an electrician far outweighs the cost of an injury.

- **Remove rings and watches that you are wearing.** They are extremely conductive material and may catch on small components.
- **Get a helper.** You are most likely going to need a third hand at some point, and you shouldn't perform electrical work without someone close by to help if you get hurt.
- **Be patient.** Take your time and stay alert. Never shortcut or become too confident in what you are doing; electrical power will always be stronger than you.
- **Take notes** recording what you have checked, and what the readings were. This is also a good way to check your work when you are finished. Sometimes, the machine won't work because a wire was removed for testing, and overlooked when cleaning up. Having proper notes will make the process go much more smoothly.
- **ALWAYS turn the power off** if you are checking for ohms or swapping PLC cards.
- **ALWAYS push an E-stop button and lockout/tagout** when possible before approaching a machine for any reason. If working with the encoders it is especially important. An interruption to a powered encoder may cause components to move without warning.
- **Wear appropriate personal protective equipment (PPE)** for working with live power.

Getting Started With Troubleshooting

Tools Needed



Gather these tools before beginning the troubleshooting process and before calling MiTek for technical assistance.

1. Slotted screwdriver, insulated
2. Phillips screwdriver, insulated
3. Equipment manual and drawings, specifically electrical schematics
4. Pen and paper to take notes and document settings
5. Multimeter

A multimeter is an electronic measuring instrument. The analog versions were referred to as an analog volt-ohm-meter (VOM). A newer, digital model is called a digital-multi-meter (DMM). There are a large variety of volt-measuring devices available, but at a minimum, it should have these features:

- Voltage (volts) measurement
 - Resistance (ohms) measurement
 - Ability to measure both AC and DC power
 - Autoranging feature
 - It is highly beneficial to also have the ability to measure current (amps)
6. Various additional tools depending on which parts are in question
 7. Personal protective equipment as dictated by NFPA 70E

The First Steps

For Mechanical Troubleshooting

Always clean and lubricate the equipment as a first step in most troubleshooting processes. Most mechanical malfunctions are caused by inadequate preventive maintenance.



For Electrical Troubleshooting



1. Lockout/tagout at the disconnect switch located on the equipment.

	NOTICE
	<p>Never use compressed air inside the electrical enclosures! It may force contaminants into the electrical connections.</p> <p>Use a vacuum to remove dust from electrical enclosures. Canned air is acceptable after vacuuming.</p>

2. Vacuum and dust the electrical enclosure.
3. Remove the lockout/tagout equipment and attempt to run the machine again. If that didn't fix the problem, proceed with the next step.
4. Adhere to all regulations and guidelines given in NFPA 70E and in your company's energy control program. Some important safety tips are also addressed on page 141.

	 WARNING
	<p>ELECTROCUTION HAZARD!</p> <p>All electrical work must be performed by a licensed electrician.</p> <p>If it is absolutely necessary to troubleshoot an energized machine, follow appropriate guidelines.</p>

5. Determine where the electrical problem begins. To do this, you need a multimeter. If you are unfamiliar with your multimeter, consult the manufacturer's manual.

Measure incoming and outgoing voltage to specific components. Proceed along a logical order determined by your machine's specific problem, and write down the order that you check each item and the amount of voltage that it registers. For this machine, follow these guidelines:

- a) Have a licensed electrician check the voltage at the hydraulic directional-control valve coils with the joystick activated in the appropriate direction.
- b) If 120 VAC is not present, check the control buttons, joystick and wiring.
- c) If 120 VAC is present, turn off the electrical power and check the coils with an Ohm meter. If it reads an open circuit, the coils are burned out.
- d) If the control power and valve coils appear to be functioning, test the hydraulic system.



Should you lockout/tagout to safely perform this action?



Symptoms and Solutions

Table A-1: Basic Troubleshooting for the Auto 8/10 System

Problem	Possible Cause	Possible Solution	See Page
Machine will not start. (Green Control Power On light will not come on.)	Main power is turned off.	Turn on main power source from your plant. A disconnect switch is typically on the wall near the table disconnect switch.	xvii
	Table disconnect switch is off.	Turn on the table disconnect switch.	40
	Fuses are blown.	Replace main disconnect fuses in main electrical enclosure.	30
At main power:	Key switch is turned off.	Turn key to On position and press the START button. (Green Control Power On light will energize.)	40
	One of the two E-stop buttons is pressed.	Pull out the E-stop button and press the START button. (Green Control Power On light will energize.)	
	One or two safety shutoff bar limit switches are not activated (only previous designs have safety shutoff bar).	Lower the safety shut-off bar to Down position, then adjust the safety shut-off bar limit switch if necessary.	
Machine will not start. (Green Control Power On light will not come on.)	Electric motor has been overloaded and the motor overloads are tripped.	Wait 2 to 4 minutes and press the motor Reset button on the main electrical enclosure.	
	Primary and secondary control circuit fuses are blown.	Have a licensed electrician check fuses and electrical circuit to determine the reason why the fuse has blown. Do not simply replace the fuse.	
	Control Power On light bulb is burned out.	Replace the light bulb.	136



Should you lockout/tagout to safely perform this action?





Table A-1: Basic Troubleshooting for the Auto 8/10 System (Continued)

Problem	Possible Cause	Possible Solution	See Page
	The machine is not receiving complete 3-phase power from the main shop breaker.	Reset the main shop breaker. Have a licensed electrician ensure that all 3-phase power is at the correct voltage.	
The machine starts for a short time but then shuts off. (Green Control Power On light and electrical motor shut off.) Motor is single phasing and trips the overloads.	The machine is not receiving complete 3 phase power from the electrical conductor rail under the table. There may be a dead zone in the conductor rail, caused by misalignment or arcing. The electric motor is not receiving complete 3 phase power, due to a loose connection in the main electrical enclosure.	Turn off and lockout the main power to the machine. Have a licensed electrician check that the four pickup arm shoes are in good condition and are fully contacting the electrical conductor rail. Replace the pickup arm shoes and rail section, if damaged. Check for 3-phase power at the starter. Have a qualified electrician check for 3-phase power at the starter, the disconnect fusing at the main electrical enclosure, and the motor overloads to ensure the motor is not single phasing.	40
	Electric motor is overloading, and the overload heaters are shutting off the power.	Have a licensed electrician check the motor, and have the hydraulics personnel check the hydraulic system.	135
The machine starts for a short time but then shuts off. (Green Control Power On light and electrical motor shut off.) Motor is overloaded and trips the overloads.	Hydraulic relief valve or unloading valves are set to high. The machine is exposed to temperatures lower than 32°F (0°C). The hydraulic fluid is too thick and is causing the electric motor to overload.	Readjust complete hydraulic system. Change the hydraulic fluid to the correct viscosity for the ambient temperature. Install auxiliary in-tank heater. Relocate machine to heated building.	81 69
	Motor overloads are set to the wrong amperage. Motor is wired to the wrong voltage.	Have a licensed electrician set motor overloads to the correct settings. Have a licensed electrician check the motor connection.	
The machine starts but will not travel or press (motor sounds loaded.)	The machine is stuck in the Up mode.	The Up limit switch is not being activated.	99



Should you lockout/tagout to safely perform this action?





Table A-1: Basic Troubleshooting for the Auto 8/10 System (Continued)

Problem	Possible Cause	Possible Solution	See Page
The machine stops abruptly while traveling. (Green Control Power On light and motor stays on.)	A jig bolt is protruding through the table top, and the lower machine frame is hitting it.	Replace the jig bolt with one of the correct length.	140
The machine starts or stops too abruptly in one or both directions.	The drive system cushion valve is set incorrectly to a pressure greater than 1600 psi.	Adjust the drive cushion valve setting.	80
	Joystick is broken.	Have a licensed electrician check electrical circuit. Replace joystick.	
The machine starts but will not press or travel.	The machine is stuck in the Up mode.	The 'Up' limit switch is not being activated.	99
	Relief valve has backed off.	Have hydraulic personnel check the hydraulic system.	81
	Low or no hydraulic fluid in tank.	Refill tank to correct level.	71
	The electric motor is running backwards.	Have a licensed electrician check the motor/pump rotation and correct, if necessary. (The direction of rotation is marked on the pump.)  Turn off power at plant power source first!	
The machine starts too slowly and coasts too far.	Drive and idler wheels are not level.	Level the press head.	107
	The track or drive wheels are dirty or oily.	Clean the track and wheels.	100
	Drive wheels are worn out.	Inspect the drive wheels.	101
	The drive system cushion valve is set incorrectly to a pressure less than 1500 psi.	Adjust the drive cushion valve setting.	80
The machine continues to travel after the joystick is released.	Hydraulic valve is not returning to the neutral position.	Check valve operation. Clean/replace valves.	83
	Joystick is broken.	Have a licensed electrician check electrical circuit. Replace joystick.	
The gantry head travels unevenly (dogtracks) down the track.	The guide wheels need adjustment or are worn out.	Adjust the head tracking guide wheel.	110
	One drive wheel or motor is not functioning properly.	Inspect drive wheels and drive motors.	





Should you lockout/tagout to safely perform this action?

Table A-1: Basic Troubleshooting for the Auto 8/10 System (Continued)

Problem	Possible Cause	Possible Solution	See Page
One drive wheel tends to spin when starting or skid when stopping.	The track is dirty on that side.	Clean the track and wheels. Adjust the track wiper.	100
	The 4 wheels are not sitting level on the track because the table is not level.	Level the table at both ends.	
	The table is level but the 4 wheels are not level with each other.	Level the wheels with each other.	107
	The wheels are not the same diameter.	Measure the wheels and replace if necessary.	103
The machine is wearing off the drive wheel rubber.	One drive wheel or drive motor is defective.	Inspect both drive wheels. Inspect both drive motors and spline connection.	
	Wheels are not level with each other.	Level the wheels with each other.	107
	One drive wheel or drive motor is worn out.	Inspect both drive wheels. Inspect both drive motors and spline connection.	
	The head is dog tracking on the table.	Adjust the head tracking guide wheel.	110
Connector plates are not fully seated	The drive pressure is set incorrectly, causing the wheels to spin and skid.	Adjust the drive cushion valve setting.	80
	Pressing force is set too low.	Use Boost force.	45
	Truss components are of varying thicknesses.	Adjust hydraulic pressure. Use only lumber of same thickness.	81
	The total area of connector plates is greater than the machine's pressing capacity.	Use a 2-stage pressing process.	
Lumber is damaged during pressing operation.	Pressing force too high.	Do not use Boost Force. Lower normal working pressure setting.	45
	Truss components are of varying thicknesses.	Use only lumber of same thickness.	
The machine presses but will not come back up (stuck in 'Down' mode.)	The pressure switch is set at a higher setting than the relief valve.	Have hydraulic personnel check the hydraulic system.	81



Should you lockout/tagout to safely perform this action?



Table A-1: Basic Troubleshooting for the Auto 8/10 System (Continued)

Problem	Possible Cause	Possible Solution	See Page
Machine is overheating	Oil filter is plugged.	Replace oil filter.	74
	Low hydraulic fluid.	Refill tank to correct oil level.	71
	Relief valve or unloading valve set incorrectly.	Reset relief and unloading valves.	78
	Incorrect valve has been installed.	Install new valve to meet factory specifications.	
Travel warning beacon does not flash.	The lamp is burned out.	Replace the beacon lamp.	129
Broken pin lock.	Insufficient grease causing bushing to bind on pin.	Remove pin and check pin and bushing for damage. Replace, if required.	
		Remove broken pin lock and install a new one.	
Brass shavings around linkage pin.	Insufficient greasing has caused bushing to bind on pin.	Remove pin and check pin bushing for damage. Replace, if required. Grease daily.	
Bushing will not take grease.	Insufficient greasing has caused bushing to spin in housing.	Remove pin. Remove grease fitting. Using a hand drill, drill a new hole through the bushing. Replace grease fitting. Grease daily.	
Excessive movement between pin and bushing.	Insufficient greasing has caused bushing and/or pins to wear.	Replace bushings and pins.	
Oil leaking at valve mounting surface	Valve mounting bolts are not torqued correctly.	Replace O-rings and re-torque valve-mounting bolts.	
	Damaged or incorrectly positioned O-rings or wrong O-rings.	Replace O-rings and re-torque valve-mounting bolts.	
	Hydraulic pressure is set too high.	Readjust hydraulic pressure.	
	Machine is running too hot.	Refer to overheating problem on page 149.	
Hydraulic cylinder is leaking around the rod and gland	Oil trapped in hydraulic cylinder requires changing.	Change hydraulic fluid.	75
	Rod gland seals are worn.	Replace gland seals.	
	Rod has burr which damages gland seals.	Repair/replace cylinder rod. Replace gland seals.	
Hydraulic cylinder is leaking around barrel.	Tie rods are not torqued correctly.	Replace barrel seals and re-torque tie rods.	



Should you lockout/tagout to safely perform this action?



Table A-1: Basic Troubleshooting for the Auto 8/10 System (Continued)

Problem	Possible Cause	Possible Solution	See Page
Pressing platen creeps down when not in use.	Hydraulic cylinder seals are worn.	Rebuild cylinder.	
	Pressing valve seals are worn out.	Rebuild/replace valve.	
Back pressure is greater than 200 psi in hydraulic system at idle.	Oil filter is plugged.	Replace oil filter.	
	Hydraulic valve is not returning to the neutral position.	Check valve operation. Clean/replace valves.	
	Incorrect valve has been installed.	Install new valve to meet factory specifications.	

For Machines Manufactured Prior to 2012

For Machines Equipped With an Electronic Safety Module (ESM)

General Description of ESM Safety Circuit

Machines equipped with an electronic safety module (ESM) route all of the safety circuits directly into the ESM. The ESM is used to detect faults in the wiring and safety devices which may not be discovered in conventional safety circuits. Each safety device, such as an emergency stop button, or limit switch on a shut-off bar, has two internal circuits which connect to the ESM. The ESM sends DC voltages through the safety devices which are connected in series. When the proper DC voltages arrive back at the ESM, it is assumed that the safety devices and their circuits are functioning properly. When the ESM receives that Start signal, the electronic relay contacts close, allowing the proper voltages to be sent to the rest of the control circuit, thus allowing the machine to be started.

The use of two circuits (safety circuits 'A' and 'B') for each safety device has the following advantages:

1. The probability of both safety circuit 'A' and safety circuit 'B' simultaneously failing and rendering the safety device inoperative is greatly reduced, versus a safety device which only has a single circuit.
2. The ESM sends a positive DC voltage through safety circuit 'A' and a negative DC voltage through circuit 'B'. When the correct DC voltages are received back at the ESM, the possibility that pinched wires have bypassed the safety devices is eliminated.
3. The ESM measures operating time difference between safety circuit 'A' and 'B' in milliseconds. Since the safety device should break both circuits simultaneously, a delay in the circuit activation would indicate a fault in the safety device or wiring. The ESM would pick up this delay as a fault and the ESM would have to be reset before it could be restarted. The activation of certain safety devices, such as the safety shut-off bars, which use limit switches, sometimes produce a Fault reading.

Description of the 4 Lights (LED's) on the ESM



1. A1/A2 LED will be energized when the safety module is receiving 120VAC from the control circuit on terminals A1 and A2. (A1 is hot, A2 is neutral.)
2. INPUT A LED will be energized when safety circuit 'A' is properly functioning. A positive DC voltage goes out on terminal S11, through all of the 'closed' safety devices, and back in on terminal S12. When the correct positive DC voltage arrives on terminal S12, the INPUT A LED comes on.

3. INPUT B LED will be energized when safety circuit 'B' is properly functioning. A negative DC voltage goes out on terminal S21, through all of the 'closed' safety devices, and back in on terminal S22. When the correct negative DC voltage arrives on terminal S22, the INPUT B LED comes on.
4. OUTPUT K1/K2 LED When both INPUT A and INPUT B LED's are energized, indicating that all safety devices are closed and the wiring to these devices is functioning properly, the control power may be started. The START button sends positive DC voltage from terminal S12 (or S33) to S34 which, in turn, closes two internal relays, energizing terminals 14 and 24 and also energizing the OUTPUT K1/K2 LED.
5. TERMINALS 14 and 24 on the electronic safety module power two additional safety relays. One is for immediate (B) control and power loss for travel and press down functions, and one is for time delayed (C) control and power loss for the motor and press up functions.

LED Light Status

- POWER light is ON when Safety Module is powered (120VAC).
- CH1 light is ON when Safety Circuit A (S11 - S12) is properly functioning.
- CH2 light is ON when Safety Circuit B (S21 - S22) is properly functioning.
- FAULT light is ON when both Safety Circuits are properly functioning and the START button is pressed.

ESM Troubleshooting Procedure

 WARNING	
 	<p>ELECTROCUTION HAZARD.</p> <p>Always turn the power off by activating an E-stop when the equipment is not in operation.</p> <p>Always verify that all power to the machine has been turned off and follow approved lockout/tagout safety procedures (OSHA 29 CFR 1910.147) before performing any maintenance on this equipment.</p> <p>If it is absolutely necessary to troubleshoot an energized machine, follow NFPA 70E or the governing regulations at your location for proper procedures and personal protective equipment.</p>

Resetting the ESM

If the ESM has detected an operating time fault in a safety circuit, it must be reset before it can be restarted. The ESM is reset by removing the 120VAC power for several seconds.



1. Turn key switch to Off (main control power off). A1/A2 LED must go off.
2. Turn key switch to On to reset ESM. A1/A2 LED should go on.
The Input A and Input B LED's should come back on allowing the machine to be restarted.

Input A and/or Input B LED's Are Not On

1. With the ESM module reset and with A1/A2 LED on, check each safety device on the safety circuits;
 - All emergency stop buttons must be pulled out closing the safety circuits.
 - All limit switches on safety shut-off bars must be activated closing the safety circuits.
2. If this machine's safety circuit is interlocked to that of another machine in the assembly line, that machine may have to be started first in order to close the interlocking safety circuits.
 - Start all interlocked machinery.
3. To check the safety devices on safety circuit A, turn off the power and disconnect the two wires at terminals S11 and S12 on the ESM (or at the terminal strip) going to the safety devices on safety circuit A. Using an ohm meter, test for continuity on those two wires. An open circuit would indicate damaged wires or safety

devices on safety circuit A. A closed circuit would indicate a proper circuit and Input A LED should turn on when the power is restored.

4. To check the safety devices on safety circuit B, turn off the power and disconnect the wires at terminals S21 and S22 (or at the terminal strip) going to the safety devices on safety circuit B. Using an ohm meter, test for continuity on those two wires. An open circuit would indicate damaged wires or safety devices on safety circuit B. A closed circuit would indicate a proper circuit and Input B LED should turn on when the power is restored.
5. Repair safety circuits 'A' and 'B' wiring and devices if required.
6. Before reconnecting the safety circuit 'A' and 'B' wiring to the ESM, the ESM can be tested. With power to the ESM (A1/A2 LED will be on), place a temporary jumper from terminal S11 to terminal S12, Input A LED should go on. Place a temporary jumper from terminal S21 to terminal S22, Input B LED should go on. If either of these two LED's do not come on, the ESM may have been damaged. Damage can occur if the ESM safety circuits are grounded out or 120VAC is applied to the DC circuits.

 WARNING	
 	<p>Never bypass a safety circuit!</p> <p>If it is absolutely necessary to troubleshoot an energized machine, follow NFPA 70E or the governing regulations at your location for proper procedures and personal protective equipment.</p>

7. With A1/A2, Input A, and Input B LED's on, pressing the start button on the control panel will close the dry contacts between terminals S12 and S34 which will turn the Output K1/K2 LED on. 120VAC control power will be sent from ESM terminals #14 and #24 to the two cube relays (typically R1 and R2). When relays R1 and R2 close, power is supplied to the rest of the control circuit.

Navigating the Parts List Appendix

Finding the Part Number

The tables that make up this appendix are divided into sections which are presented in the order listed here. Parts are grouped first according to their location and then presented in alphabetical order by part name. The far right column indicates if the part should be kept in stock to minimize downtime.

Mechanical, Hydraulic, and Pneumatic Replacement Parts page 157

Electrical Replacement Parts page 157

Documentation and Safety Parts page 157



Ordering the Parts With Your Part Number



There are several easy ways to order your part after you determine the part number. Each column in Table B-1 describes one method.



Table B-1: How to Order Your Part Using the Part Number

Using E-Mail	Using the Phone
Send an e-mail to mitekparts@mii.com with all relevant information, including the part number.	Call 1-800-523-3380 and select "Parts Orders".

Safety Notes for Replacing Parts

	 WARNING
	<p>CRUSH, ELECTRICAL, HIGH PRESSURE HAZARDS</p> <p>Perform the safety tests described, starting on page xxi before operating the equipment at the initial startup, after performing any maintenance, and in accordance with the maintenance schedule.</p>

	 WARNING
	<p>ELECTRICAL HAZARD!</p> <p>All electrical work must be performed by a licensed electrician.</p> <p>Follow approved lockout/tagout procedures (OSHA 29 CFR 1910.147).</p>

	 WARNING
 	<p>CRUSH, ELECTRICAL, HIGH PRESSURE HAZARDS</p> <p>Always turn the power off by activating an E-stop when the equipment is not in operation.</p> <p>Always verify that all power to the machine has been turned off and follow approved lockout/tagout safety procedures (OSHA 29 CFR 1910.147) before performing any maintenance on this equipment.</p> <p>Turn off the air switch or shutoff valve if appropriate.</p> <p>Bleed pneumatic and hydraulic lines if appropriate.</p>

	NOTICE
	<p>Only use the exact replacement parts that are specified by MiTek. Substitutions may harm your equipment.</p>

Part Numbers

Mechanical, Hydraulic, and Pneumatic Parts

Table B-2: Mechanical, Hydraulic, and Pneumatic Replacement Parts

<i>MiTek</i> Part #	Part Description	Keep in Stock
30313-501	Drive and idler wheels (bearing not included)	
580205	Guide wheel (camfollower)	
30326	Wiper	1
30323	Wiper mount shim	
419264	Bearings for drive and idler wheels	
805231	Filter for hydraulic return line (not the replacement element)	
805230	Filter replacement element for hydraulic return line filter	1
442110	Seal kit for hydraulic return line filter	1
806124	Sight gauge on hydraulic fluid reservoir	
426352	Seal kit below hydraulic valve (typical after E-stop use)	1
438575	Filter element for pneumatic filter/regulator (optional equip.)	1

Electrical Parts

Table B-3: Electrical Replacement Parts

<i>MiTek</i> Part #		Part Description	Keep in Stock
516492 477058 516496	Disconnect Fuses:	30 amp for 575 V 40 amp for 460 V 60 amp for 208/230 V	1
515069		Limit switch for platen Up position	1

Documentation, Operation, and Safety Parts

Table B-4: Documentation and Safety Replacement Parts

<i>MiTek</i> Part #	Documentation
001102	Manual
691900	Restricted zone tape
010191	T-slot jiggling replacement kit (does not include pucks)
010165	T-slot jiggling pucks kit
30223-601	J-slot jiggling replacement kit



Maintenance Checklists

Appendix C

Navigating the Maintenance Checklists



These checklists guide you through all preventive maintenance tasks required to keep this equipment in top working condition.



These pages are supplied with the intent that you will photocopy them and leave the original in the manual for future use. Space is provided in each chart to place the date that the work is done and the initials of the person performing the work.

Checklist	Page
Daily Checklist	page 160
Weekly Checklist	page 161
Monthly Checklist	page 162
Annual Checklist	page 163

Auto 8/10

Safety Notes For Maintenance Checklists

	 WARNING
	<p>CRUSH HAZARD, HIGH PRESSURE HAZARD!</p> <p>Perform the safety tests described in the <i>Safety (English)</i> section on page xxvi before operating the equipment at the initial startup, after performing any maintenance, and in accordance with the maintenance schedule.</p>

	 WARNING
 	<p>ELECTROCUTION AND HIGH PRESSURE HAZARDS.</p> <p>Always turn the power off and activate an E-stop when the equipment is not in operation.</p> <p>Always verify that all power to the machine has been turned off and follow approved lockout/tagout safety procedures (OSHA 29 CFR 1910.147) before performing any maintenance on this equipment.</p> <p>Turn off the air switch or shutoff valve if appropriate.</p> <p>Bleed pneumatic and hydraulic lines if appropriate.</p>

Auto 8/10

Daily Checklist

Month and Year:

Week:

	WARNING
	Lockout/tagout before performing any maintenance! If power is required, ensure all personnel are clear.

Action	Shift	See Page	Dates						
Check the hydraulic fluid level and temperature	Shift 1	71							
	Shift 2	69							
	Shift 3								
Check hydraulic return line filter element gauge	Shift 1	74							
	Shift 2								
	Shift 3								
Daily cleaning procedure	Shift 1	page 112							
	Shift 2								
	Shift 3								
Lubricate: transfer bar rod, bellcrank, upper connecting rod, cylinder rod eye, cylinder clevis, guide rod, and lower connecting rod	Shift 1	115							
	Shift 2								
	Shift 3								



Notes	Date

Auto 8/10

Weekly Checklist

Year: _____

Month: _____

	 WARNING
	<p>Lockout/tagout before performing any maintenance!</p> <p>If power is required, ensure all personnel are clear.</p>



Action	See Page	Dates				
Hydraulic Fluid Inspection	70					
Lubricate camfollowers	120					
Drain the regulator (if system is equipped with floor jiggling)	139					

Notes	Date

Auto 8/10

Monthly Checklist

Year: _____

	 WARNING
	Lockout/tagout before performing any maintenance! If power is required, ensure all personnel are clear.



Action	Interval	See Page	JAN	FEB	MAR	APRIL	MAY	JUNE
Check the oil filter bypass gauge	1 month	73						
Perform the mechanical inspection	1 month	97						
Periodic cleaning procedure	1 month	113						

Action	Interval	See Page	JULY	AUG	SEPT	OCT	NOV	DEC
Check the oil filter bypass gauge	1 month	73						
Perform the mechanical inspection	1 month	97						
Periodic cleaning procedure	1 month	113						

Auto 8/10

Annual Checklist

Year: _____

	 WARNING
	Lockout/tagout before performing any maintenance! If power is required, ensure all personnel are clear.

Action		See Page	Sign and Date When Action is Performed				
Replace hydraulic fluid filter element (Bypass Gauge will indicate if it needs replacement sooner)	1 year	74					
Drain and replace hydraulic fluid	1 year	75					
Inspect the wheels	1 year	101					
Grease the drive wheel, idler wheels, and table guide roller	1 year	121					
Electrical inspection	1 year	134					
Check regulator filter (optional equip.)	6 months	139					

Notes

Date

Drawings are inserted at the back of the manual or in a separate binder.

Table D-1: Attached Drawings

Description	Drawing Number
Hydraulic schematic	30131-501
Floor jiggling pneumatic kit	30296-501
Gantry head mechanical assembly	30300-501
Electrical drawings	90610



Document Evaluation

Appendix E

A form is included in this appendix so you can provide MiTek with feedback on the usefulness of this manual. We make an ongoing effort to improve the value of our documentation, and your views are important to us.

Please follow the instructions on the form to provide us with comments or suggestions that will help us improve the quality of our documentation services.

Document Evaluation Form

We appreciate your comments on how we can make this document more useful.

Document Identification:

Auto 8/10™ Platen Press	Operation and Maintenance Manual	001102 Rev. C
-------------------------	----------------------------------	---------------

General Ratings:

	Poor	Fair	Good	Excellent
Content	<input type="checkbox"/>	<input type="checkbox"/>	<input type="checkbox"/>	<input type="checkbox"/>
Organization	<input type="checkbox"/>	<input type="checkbox"/>	<input type="checkbox"/>	<input type="checkbox"/>
Accuracy	<input type="checkbox"/>	<input type="checkbox"/>	<input type="checkbox"/>	<input type="checkbox"/>
Clarity	<input type="checkbox"/>	<input type="checkbox"/>	<input type="checkbox"/>	<input type="checkbox"/>
Completeness	<input type="checkbox"/>	<input type="checkbox"/>	<input type="checkbox"/>	<input type="checkbox"/>
Examples/Illustrations	<input type="checkbox"/>	<input type="checkbox"/>	<input type="checkbox"/>	<input type="checkbox"/>
Readability	<input type="checkbox"/>	<input type="checkbox"/>	<input type="checkbox"/>	<input type="checkbox"/>

Compared to other truss machinery manufacturers' documentation, how would you rate this document?

Poor Fair Good Excellent

There is room for specific suggestions on the next page. Document general comments here.

Document Evaluation Form (cont'd)

Identify any inaccuracies in the document.	
What are the three best features of the document?	
What are the three worst features of the document?	
What did you like/dislike about the illustrations?	
Your Name:	Date:
Company Name:	Address:
Phone:	E-mail:
Please mail this form to: MiTek Machinery Division 301 Fountain Lakes Industrial Drive St. Charles, MO 63301 Attn: Engineering Manager	Or fax this form to: 636-328-9218 Attn: Engineering Manager

If you do not receive a reply within 45 days, please call our Customer Service Department and ask for the Documentation Specialist or Engineering Manager: 800-523-3380.

Glossary

actuate	to activate, put into action
affected employee	an employee whose job requires him/her to operate or use a machine or equipment on which servicing or maintenance is being performed under lockout or tagout, or whose job requires him/her to work in an area in which such servicing or maintenance is being performed
amperage	the strength of an electric current, expressed in amperes
authorized employee	a person who locks out or tags out a machine or equipment in order to perform servicing or maintenance on that machine or equipment; an affected employee becomes an authorized employee when that employee's duties include performing servicing or maintenance covered under this section
connector plate	the nail-plate that is embedded into the production material to hold it together
cushion	an attribute of a hydraulic cylinder that allows adjustment of the pressure in each cylinder
energized	connected to an energy source or containing residual or stored energy
energy isolating device	a mechanical device that physically prevents the transmission or release of energy, including but not limited to the following: manually operated electrical circuit breaker; a disconnect switch; a manually operated switch by which the conductors of a circuit can be disconnected from all ungrounded supply conductors, and in addition, no circuit can be operated independently; a line valve; a block; and any similar device used to block or isolate energy—push buttons, selector switches, and other control circuit type devices are not energy isolating devices

Glossary

energy source	any source of electrical, mechanical, hydraulic, pneumatic, chemical, thermal, or other energy
gantry head	the entire traveling weldment that houses the Roller to embed the connector plates
HMI	Human Machine Interface; operator control interface
jigging	any of several devices used to hold the truss in place on the tables
joystick	a 4-position control mechanism; controls horizontal travel of the gantry head and vertical travel of the platen
layout	a scaled diagram of the location of components and the space that they occupy
limit switch	an electro-mechanical device that consists of an actuator mechanically linked to a set of contacts; when an object comes into contact with the actuator, the device operates the contacts to make or break an electrical connection
lockout device	a device that utilizes a positive means such as a lock, either key or combination type, to hold an energy isolating device in the safe position and prevent the energizing of a machine or equipment, including blank flanges and bolted slip blinds; should be standardized within the facility in at least one of the following criteria: color; shape; or size; and additionally, in the case of tagout devices, print and format shall be standardized
lockout/tagout	a means of isolating a piece of equipment from its energy source so maintenance can safely occur; guidelines provided in OSHA 29 CFR 1910.147
operator control interface	the method in which the operator controls the machine; it may be a touch screen, a control panel, etc.; also HMI (Human Machine Interface)
plate	see <i>connector plate</i>

Glossary

PLC	Programmable Logic Controller; a solid-state control device that can be programmed to control process or machine operations. It consists of five basic components: processor, memory, input/output module, the power supply, and the programming device.
port	a connection point for a peripheral device
potentiometer	a control knob that is a dial; allows a range of values to be set by turning the dial, commonly found on the PLC
proximity switch	a switch that uses an electromagnetic field to detect when an object is near, there is no physical contact between the object and the switch; inductive proximity switches detect only metal objects, capacitive proximity switches can sense both metallic and non-metallic objects
puck	a type of jigging that is small and round
qualified person	a person or persons who, by possession of a recognized degree or certificate of professional training, or who, by extensive knowledge, training, or experience, has successfully demonstrated the ability to solve problems relating to the subject matter and work—ANSI B30.2-1983; one who has skills and knowledge related to the construction and operation of the electrical equipment and installations and has received safety training on the hazards involved—NEC2002 Handbook
regulator	a component of the pneumatic system that connects to the main air source and regulates the air pressure allowed into the system
setup valve	a component of the pneumatic system that control the flow of air to the rest of the setup
slot filler	a small steel pad that can be placed in a jigging slot if a connector plate is located on the slot

Glossary

solenoid	an assembly used as a switch consisting of a coil and a metal core free to slide along the coil axis under the influence of the magnetic field
stand-alone conveyor	the conveyor system that carries the truss from the tables to the Finish Roller and out to the stacker
stop	a type of jigging that is long and straight
tagout device	a prominent warning device, such as a tag and a means of attachment, which can be securely fastened to an energy isolating device in accordance with an established procedure, to indicate that the energy isolating device and the equipment being controlled may not be operated until the tagout device is removed; should be standardized within the facility in at least one of the following criteria: color; shape; or size; and additionally, in the case of tagout devices, print and format shall be standardized
torque	a turning or twisting force
VFD	Variable Frequency Device; controls the speed of the cycle on some machines, is not in use on this equipment
voltage	Equal to the difference of electric potential between two point on a conducting wire carrying a constant current of one ampere when the power between the points is one watt